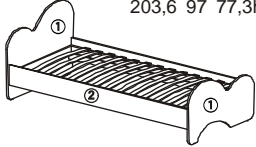
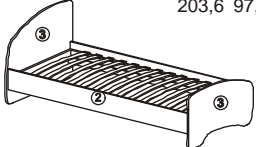
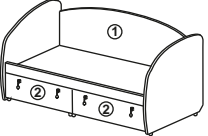
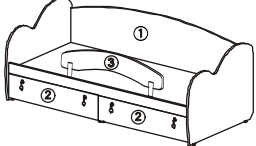
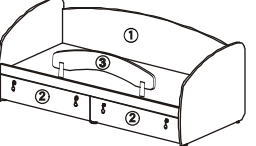
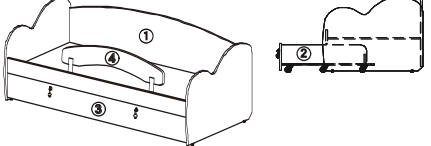
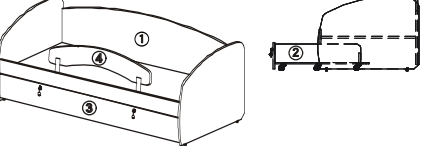

Прайс-лист цены на детскую, молодежную, подростковую мебель и спальни производства Софтформ

Прайс-лист цены на детскую, молодежную, подростковую мебель МИА (МИА), 15-08-2013 Софтформ

 <p>203,6 97 77,3h</p>		 <p>203,6 97,5 78,6h</p>		 <p>163,6 77 79,5h</p>	
		90 200			
1	147101	1		710 280 p.	
2	147501	1		1 676 760 p.	
3	147102	1		727 800 p.	
				70 160	
1			298602	1	2 976 240 p.
2			297601	2	181 080 p.

 <p>203,6 96,4 79,5h</p>		 <p>203,6 96,4 79,5h</p>			
		90 200			
1	148601	1		3 306 840 p.	
2	147601	2		197 520 p.	
3	-	140004	1	445 320 p.	
120 1,8 26,5h				90 200	
				90 200	
1			148602	1	3 306 840 p.
2			147601	2	197 520 p.
3			140004	1	445 320 p.
120 1,8 26,5h				90 200	

 <p>203,6 96,4 79,5h</p>		 <p>203,6 96,4 79,5h</p>			
		90 200			
1	148603	1		2 204 160 p.	
2	148703	1		1 208 880 p.	
3	147611	1		329 400 p.	
4	-	140004	1	445 320 p.	
120 1,8 26,5h				90 200	
				80 190	
1			148604	1	2 204 160 p.
2			148703	1	1 208 880 p.
3			147611	1	329 400 p.
4			140004	1	445 320 p.
120 1,8 26,5h				90 200	

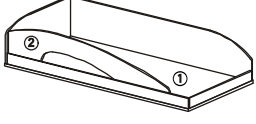
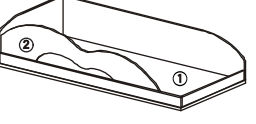
 <p>204,2 96 45h</p>		 <p>204,2 96 48,3h</p>				
		90 200				
1	147509	147510	1		1 726 800 p.	
2	147605	147606	1		358 920 p.	
				90 200		
1			147509	147510	1	1 726 800 p.
2			147603	147604	1	404 880 p.

Прайс-лист цены на детскую, молодежную, подростковую мебель МИА (MIA), 15-08-2013 Софтформ

2-		203,6 95,6 140h	
90 200			
	()	()	
1	147507	147508	1 . 2 023 440 p.
2	146311	146311	1 . 239 040 p.
3	145101	145100	1 . 308 280 p.

2-		203,6 95,6 140h	
90 200			
	()	()	
1	147516	147516	1 . 3 246 720 p.
2	146310	146310	1 . 270 360 p.
3	147601	147601	2 . 197 520 p.

2-		203,6 95,6 140h	
90 200			
	()	()	
1	147503	147503	1 . 1 313 280 p.
2	146310	146310	1 . 270 360 p.

2-		203,6 95,6 140h	
90 200			
	()	()	
1	147517	147517	1 . 2 852 640 p.
2	146310	146310	1 . 270 360 p.
3	148703	148703	1 . 1 208 880 p.
4	147611	147611	1 . 329 400 p.

2-		44,6 110,5 127,5h	
60,4 45 74h			
	()	()	
1	142903	142903	1 . 2 962 440 p.
2	147607	147607	4 . 127 200 p.

2-		44,6 45 74h	
82,4 45 74h			
	()	()	
1	142904	142904	1 . 1 588 080 p.
2	147609	147609	3 . 128 280 p.
3	147209	147209	1 . 121 560 p.

2-		44,6 45 65h	
44,6 45 65h			
	()	()	
1	142902	142902	1 . 1 361 760 p.
2	147602	147602	2 . 124 320 p.

2-		44,6 45 65h	
44,6 45 65h			
	()	()	
1	142901	142901	1 . 1 369 200 p.
2	147602	147602	2 . 124 320 p.

2-		204,2 136,4 185h	
90 200			
	()	()	
1	147709	147710	1 . 3 049 200 p.
2	147605	147606	1 . 358 920 p.

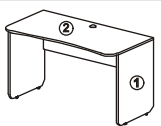
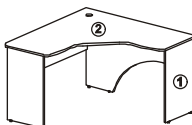
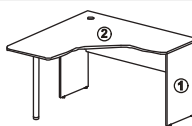
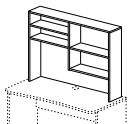
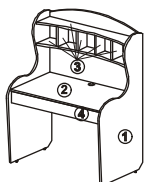
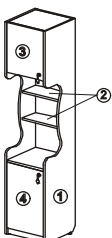
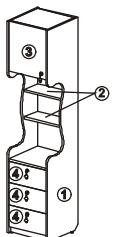
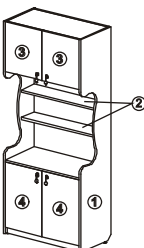
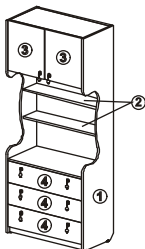
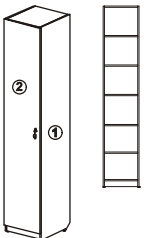

2-		200 50 72h	
90 200			
	()	()	
1	147514	147515	1 . 780 240 p.
2	147204	147205	1 . 458 760 p.
3	142302	142302	1 . 509 520 p.
4	147612	147612	2 . 362 400 p.

Прайс-лист цены на детскую, молодежную, подростковую мебель МИА (MIA), 15-08-2013 Софтформ

 <p>123 62 74h</p> <table border="1"> <tr><td>1</td><td>147511</td><td>1</td><td>541 680 p.</td></tr> <tr><td>2</td><td>147201</td><td>1</td><td>402 480 p.</td></tr> </table>  <p>123 123 74h</p> <table border="1"> <tr><td>1</td><td>147512</td><td>1</td><td>785 280 p.</td></tr> <tr><td>2</td><td>147202</td><td>1</td><td>840 600 p.</td></tr> </table>	1	147511	1	541 680 p.	2	147201	1	402 480 p.	1	147512	1	785 280 p.	2	147202	1	840 600 p.	 <p>151,4 123 74h</p> <table border="1"> <tr><td>1</td><td>147518</td><td>147518</td><td>1</td><td>681 480 .</td></tr> <tr><td>2</td><td>147206</td><td>147207</td><td>1</td><td>856 440 p.</td></tr> </table>  <p>110 20 85,4h</p> <table border="1"> <tr><td>146411</td><td>1 054 080 p.</td></tr> </table>	1	147518	147518	1	681 480 .	2	147206	147207	1	856 440 p.	146411	1 054 080 p.								
1	147511	1	541 680 p.																																		
2	147201	1	402 480 p.																																		
1	147512	1	785 280 p.																																		
2	147202	1	840 600 p.																																		
1	147518	147518	1	681 480 .																																	
2	147206	147207	1	856 440 p.																																	
146411	1 054 080 p.																																				
 <p>103,6 64 143h</p> <table border="1"> <tr><td>1</td><td>147513</td><td>1</td><td>1 393 920 p.</td></tr> <tr><td>2</td><td>147203</td><td>1</td><td>234 720 p.</td></tr> <tr><td>3</td><td>146501</td><td>1</td><td>445 440 p.</td></tr> <tr><td>4</td><td>147600</td><td>1</td><td>615 000 p.</td></tr> </table>	1	147513	1	1 393 920 p.	2	147203	1	234 720 p.	3	146501	1	445 440 p.	4	147600	1	615 000 p.	 <p>44,6 45 210h</p> <table border="1"> <tr><td>1</td><td>144107</td><td>144107</td><td>1</td><td>1 708 080 .</td></tr> <tr><td>2</td><td>146312</td><td>146312</td><td>1</td><td>132 600 p.</td></tr> <tr><td>3</td><td>145104</td><td>145105</td><td>1</td><td>165 120 p.</td></tr> <tr><td>4</td><td>145106</td><td>145107</td><td>1</td><td>188 400 p.</td></tr> </table>	1	144107	144107	1	1 708 080 .	2	146312	146312	1	132 600 p.	3	145104	145105	1	165 120 p.	4	145106	145107	1	188 400 p.
1	147513	1	1 393 920 p.																																		
2	147203	1	234 720 p.																																		
3	146501	1	445 440 p.																																		
4	147600	1	615 000 p.																																		
1	144107	144107	1	1 708 080 .																																	
2	146312	146312	1	132 600 p.																																	
3	145104	145105	1	165 120 p.																																	
4	145106	145107	1	188 400 p.																																	
 <p>44,6 45 210h</p> <table border="1"> <tr><td>1</td><td>144108</td><td>144108</td><td>1</td><td>2 306 640 .</td></tr> <tr><td>2</td><td>146312</td><td>146312</td><td>1</td><td>132 600 .</td></tr> <tr><td>3</td><td>145104</td><td>145105</td><td>1</td><td>165 120 p.</td></tr> <tr><td>4</td><td>147602</td><td>147602</td><td>3</td><td>124 320 p.</td></tr> </table>	1	144108	144108	1	2 306 640 .	2	146312	146312	1	132 600 .	3	145104	145105	1	165 120 p.	4	147602	147602	3	124 320 p.	 <p>85,6 45 210h</p> <table border="1"> <tr><td>1</td><td>144109</td><td>1</td><td>2 173 680 p.</td></tr> <tr><td>2</td><td>146313</td><td>1</td><td>187 320 .</td></tr> <tr><td>3</td><td>145110</td><td>1</td><td>314 400 p.</td></tr> <tr><td>4</td><td>145109</td><td>1</td><td>358 560 p.</td></tr> </table>	1	144109	1	2 173 680 p.	2	146313	1	187 320 .	3	145110	1	314 400 p.	4	145109	1	358 560 p.
1	144108	144108	1	2 306 640 .																																	
2	146312	146312	1	132 600 .																																	
3	145104	145105	1	165 120 p.																																	
4	147602	147602	3	124 320 p.																																	
1	144109	1	2 173 680 p.																																		
2	146313	1	187 320 .																																		
3	145110	1	314 400 p.																																		
4	145109	1	358 560 p.																																		
 <p>85,6 45 210h</p> <table border="1"> <tr><td>1</td><td>144110</td><td>1</td><td>3 135 960 p.</td></tr> <tr><td>2</td><td>146313</td><td>1</td><td>187 320 p.</td></tr> <tr><td>3</td><td>145110</td><td>1</td><td>314 400 p.</td></tr> <tr><td>4</td><td>147608</td><td>3</td><td>177 480 p.</td></tr> </table>	1	144110	1	3 135 960 p.	2	146313	1	187 320 p.	3	145110	1	314 400 p.	4	147608	3	177 480 p.	 <p>41 45 210h</p> <table border="1"> <tr><td>1</td><td>144101</td><td>1</td><td>1 479 360 p.</td></tr> <tr><td>2</td><td>145102</td><td>1</td><td>406 440 p.</td></tr> </table>	1	144101	1	1 479 360 p.	2	145102	1	406 440 p.												
1	144110	1	3 135 960 p.																																		
2	146313	1	187 320 p.																																		
3	145110	1	314 400 p.																																		
4	147608	3	177 480 p.																																		
1	144101	1	1 479 360 p.																																		
2	145102	1	406 440 p.																																		

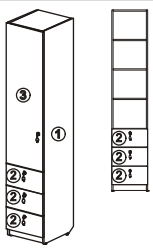
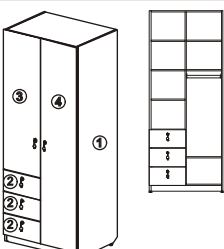
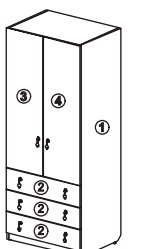
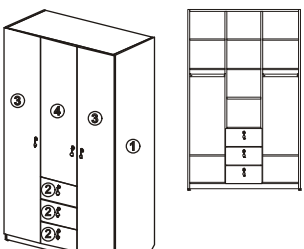
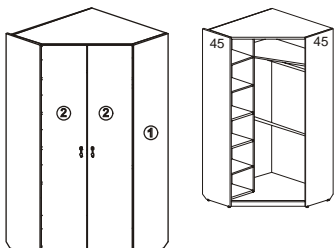
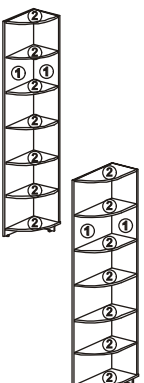
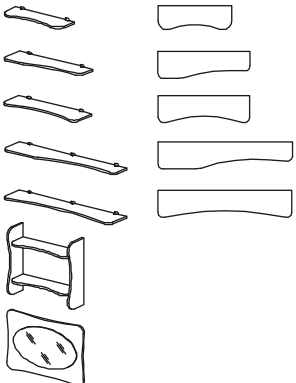
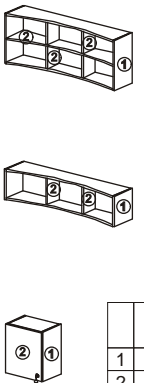

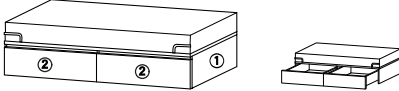
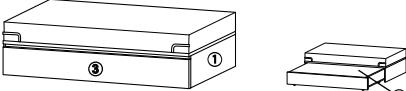
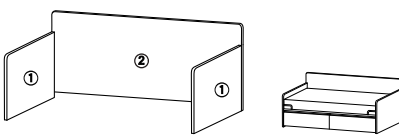
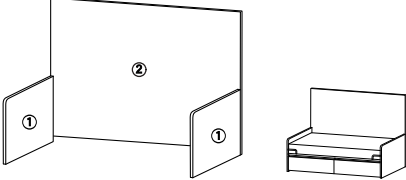
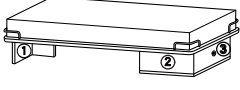

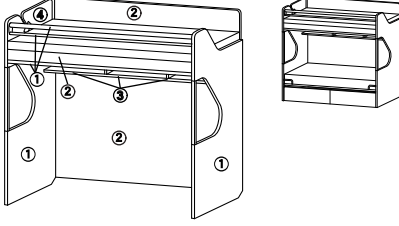
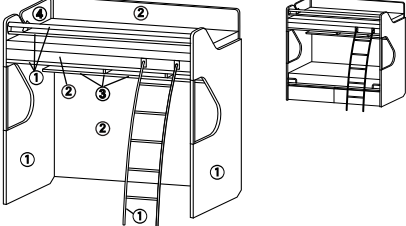



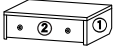

Прайс-лист цены на детскую, молодежную, подростковую мебель МИА (MIA), 15-08-2013 Софтформ

 <p>41 45 210h</p> <table border="1" data-bbox="183 548 790 660"> <tr> <td></td> <td>()</td> <td>()</td> <td></td> <td></td> </tr> <tr> <td>1</td> <td>144102</td> <td>144102</td> <td>1 .</td> <td>2 078 760 p.</td> </tr> <tr> <td>2</td> <td>147602</td> <td>147602</td> <td>3 .</td> <td>124 320 p.</td> </tr> <tr> <td>3</td> <td>145103</td> <td>145108</td> <td>1 .</td> <td>298 200 p.</td> </tr> </table>		()	()			1	144102	144102	1 .	2 078 760 p.	2	147602	147602	3 .	124 320 p.	3	145103	145108	1 .	298 200 p.	 <p>82 60 210h</p> <table border="1" data-bbox="1029 526 1492 660"> <tr> <td>1</td> <td>144103</td> <td>1 .</td> <td>3 149 760 p.</td> </tr> <tr> <td>2</td> <td>147602</td> <td>3 .</td> <td>124 320 p.</td> </tr> <tr> <td>3</td> <td>145103</td> <td>1 .</td> <td>298 200 p.</td> </tr> <tr> <td>4</td> <td>145102</td> <td>1 .</td> <td>406 440 p.</td> </tr> </table>	1	144103	1 .	3 149 760 p.	2	147602	3 .	124 320 p.	3	145103	1 .	298 200 p.	4	145102	1 .	406 440 p.				
	()	()																																							
1	144102	144102	1 .	2 078 760 p.																																					
2	147602	147602	3 .	124 320 p.																																					
3	145103	145108	1 .	298 200 p.																																					
1	144103	1 .	3 149 760 p.																																						
2	147602	3 .	124 320 p.																																						
3	145103	1 .	298 200 p.																																						
4	145102	1 .	406 440 p.																																						
 <p>82 60 210h</p> <table border="1" data-bbox="327 974 790 1108"> <tr> <td>1</td> <td>144104</td> <td>1 .</td> <td>3 314 040 p.</td> </tr> <tr> <td>2</td> <td>147608</td> <td>3 .</td> <td>177 480 p.</td> </tr> <tr> <td>3</td> <td>145103</td> <td>1 .</td> <td>298 200 p.</td> </tr> <tr> <td>4</td> <td>145108</td> <td>1 .</td> <td>298 200 p.</td> </tr> </table>	1	144104	1 .	3 314 040 p.	2	147608	3 .	177 480 p.	3	145103	1 .	298 200 p.	4	145108	1 .	298 200 p.	 <p>123 60 210h</p> <table border="1" data-bbox="1029 974 1492 1108"> <tr> <td>1</td> <td>144105</td> <td>1 .</td> <td>4 022 400 p.</td> </tr> <tr> <td>2</td> <td>147602</td> <td>3 .</td> <td>124 320 p.</td> </tr> <tr> <td>3</td> <td>145102</td> <td>2 .</td> <td>406 440 p.</td> </tr> <tr> <td>4</td> <td>145103</td> <td>1 .</td> <td>298 200 p.</td> </tr> </table>	1	144105	1 .	4 022 400 p.	2	147602	3 .	124 320 p.	3	145102	2 .	406 440 p.	4	145103	1 .	298 200 p.								
1	144104	1 .	3 314 040 p.																																						
2	147608	3 .	177 480 p.																																						
3	145103	1 .	298 200 p.																																						
4	145108	1 .	298 200 p.																																						
1	144105	1 .	4 022 400 p.																																						
2	147602	3 .	124 320 p.																																						
3	145102	2 .	406 440 p.																																						
4	145103	1 .	298 200 p.																																						
 <p>102,8 102,8 210h</p> <table border="1" data-bbox="327 1467 790 1556"> <tr> <td>1</td> <td>144106</td> <td>1 .</td> <td>3 087 000 p.</td> </tr> <tr> <td>2</td> <td>145102</td> <td>2 .</td> <td>406 440 p.</td> </tr> </table>	1	144106	1 .	3 087 000 p.	2	145102	2 .	406 440 p.	 <p>30 43 210h</p> <table border="1" data-bbox="965 1187 1492 1276"> <tr> <td>1</td> <td>147103</td> <td>147103</td> <td>1</td> <td>579 000 p.</td> </tr> <tr> <td>2</td> <td>146314</td> <td>146315</td> <td>1</td> <td>703 200 p.</td> </tr> </table> <p>30 58 210h</p> <table border="1" data-bbox="965 1467 1492 1556"> <tr> <td>1</td> <td>147104</td> <td>147104</td> <td>1</td> <td>658 920 p.</td> </tr> <tr> <td>2</td> <td>146316</td> <td>146317</td> <td>1</td> <td>810 960 p.</td> </tr> </table>	1	147103	147103	1	579 000 p.	2	146314	146315	1	703 200 p.	1	147104	147104	1	658 920 p.	2	146316	146317	1	810 960 p.												
1	144106	1 .	3 087 000 p.																																						
2	145102	2 .	406 440 p.																																						
1	147103	147103	1	579 000 p.																																					
2	146314	146315	1	703 200 p.																																					
1	147104	147104	1	658 920 p.																																					
2	146316	146317	1	810 960 p.																																					
 <p>64,8 22,2 1,8h 82 25 1,8h 82 25 1,8h 120 25 1,8h 120 25 1,8h 68,4 22,5 64,8h 82 1,8 60h</p> <table border="1" data-bbox="550 1803 790 2004"> <tr> <td>146309</td> <td>269 160 p.</td> </tr> <tr> <td>146306</td> <td>291 720 p.</td> </tr> <tr> <td>146304</td> <td>295 920 p.</td> </tr> <tr> <td>146305</td> <td>408 960 p.</td> </tr> <tr> <td>146303</td> <td>413 160 p.</td> </tr> <tr> <td>146308</td> <td>542 520 p.</td> </tr> <tr> <td>140003</td> <td>742 920 p.</td> </tr> </table>	146309	269 160 p.	146306	291 720 p.	146304	295 920 p.	146305	408 960 p.	146303	413 160 p.	146308	542 520 p.	140003	742 920 p.	 <p>123 27 49,4h</p> <table border="1" data-bbox="1061 1635 1492 1724"> <tr> <td>1</td> <td>146318</td> <td>1 .</td> <td>852 360 p.</td> </tr> <tr> <td>2</td> <td>147301</td> <td>1</td> <td>286 680 p.</td> </tr> </table> <p>123 27 30,2h</p> <table border="1" data-bbox="1061 1780 1492 1870"> <tr> <td>1</td> <td>146319</td> <td>1 .</td> <td>776 520 p.</td> </tr> <tr> <td>2</td> <td>147302</td> <td>1</td> <td>79 680 p.</td> </tr> </table> <p>41 29 49,4h</p> <table border="1" data-bbox="917 1915 1492 2004"> <tr> <td>1</td> <td>146307</td> <td>146307</td> <td>1 .</td> <td>556 320 p.</td> </tr> <tr> <td>2</td> <td>145104</td> <td>145105</td> <td>1 .</td> <td>165 120 p.</td> </tr> </table>	1	146318	1 .	852 360 p.	2	147301	1	286 680 p.	1	146319	1 .	776 520 p.	2	147302	1	79 680 p.	1	146307	146307	1 .	556 320 p.	2	145104	145105	1 .	165 120 p.
146309	269 160 p.																																								
146306	291 720 p.																																								
146304	295 920 p.																																								
146305	408 960 p.																																								
146303	413 160 p.																																								
146308	542 520 p.																																								
140003	742 920 p.																																								
1	146318	1 .	852 360 p.																																						
2	147301	1	286 680 p.																																						
1	146319	1 .	776 520 p.																																						
2	147302	1	79 680 p.																																						
1	146307	146307	1 .	556 320 p.																																					
2	145104	145105	1 .	165 120 p.																																					

 <p>200 91,8 35,8h</p> <p>90 200</p> <table border="1"> <tr><td>1</td><td>268801</td><td>1</td><td>2 397 720 p.</td></tr> <tr><td>2</td><td>265904</td><td>1</td><td>334 200 p.</td></tr> <tr><td>2</td><td>365904</td><td>1</td><td>1 014 000 p.</td></tr> </table>	1	268801	1	2 397 720 p.	2	265904	1	334 200 p.	2	365904	1	1 014 000 p.	 <p>200 91,8 35,8h</p> <p>90 200 80 190</p> <table border="1"> <tr><td>1</td><td>268806</td><td>1</td><td>1 506 480 p.</td></tr> <tr><td>2</td><td>268703</td><td>1</td><td>1 100 040 p.</td></tr> <tr><td>3</td><td>265113</td><td>1</td><td>304 080 p.</td></tr> <tr><td>3</td><td>365113</td><td>1</td><td>977 640 p.</td></tr> </table>	1	268806	1	1 506 480 p.	2	268703	1	1 100 040 p.	3	265113	1	304 080 p.	3	365113	1	977 640 p.				
1	268801	1	2 397 720 p.																														
2	265904	1	334 200 p.																														
2	365904	1	1 014 000 p.																														
1	268806	1	1 506 480 p.																														
2	268703	1	1 100 040 p.																														
3	265113	1	304 080 p.																														
3	365113	1	977 640 p.																														
 <p>204 94 84,5h</p> <p>- 64,5h</p> <table border="1"> <tr><td>1</td><td>267103</td><td>1</td><td>597 000 p.</td></tr> <tr><td>2</td><td>267406</td><td>1</td><td>599 400 p.</td></tr> </table>	1	267103	1	597 000 p.	2	267406	1	599 400 p.	 <p>204 94 140,1h</p> <p>- 64,5h</p> <table border="1"> <tr><td>1</td><td>267103</td><td>1</td><td>597 000 p.</td></tr> <tr><td>2</td><td>267407</td><td>1</td><td>834 840 p.</td></tr> </table>	1	267103	1	597 000 p.	2	267407	1	834 840 p.																
1	267103	1	597 000 p.																														
2	267406	1	599 400 p.																														
1	267103	1	597 000 p.																														
2	267407	1	834 840 p.																														
 <p>206 96 27,8h</p> <p>90 200</p> <table border="1"> <tr><td>1</td><td>268802</td><td>1</td><td>962 400 p.</td></tr> <tr><td>2</td><td>262909</td><td>1</td><td>1 462 680 p.</td></tr> <tr><td>3</td><td>265181</td><td>1</td><td>135 960 p.</td></tr> <tr><td>3</td><td>365181</td><td>1</td><td>333 120 p.</td></tr> </table>	1	268802	1	962 400 p.	2	262909	1	1 462 680 p.	3	265181	1	135 960 p.	3	365181	1	333 120 p.	 <p>206 126 27,8h</p> <p>120 200</p> <table border="1"> <tr><td>1</td><td>268803</td><td>1</td><td>1 166 280 p.</td></tr> <tr><td>2</td><td>262912</td><td>1</td><td>1 586 640 p.</td></tr> <tr><td>3</td><td>265112</td><td>1</td><td>172 200 p.</td></tr> <tr><td>3</td><td>365112</td><td>1</td><td>467 740 p.</td></tr> </table>	1	268803	1	1 166 280 p.	2	262912	1	1 586 640 p.	3	265112	1	172 200 p.	3	365112	1	467 740 p.
1	268802	1	962 400 p.																														
2	262909	1	1 462 680 p.																														
3	265181	1	135 960 p.																														
3	365181	1	333 120 p.																														
1	268803	1	1 166 280 p.																														
2	262912	1	1 586 640 p.																														
3	265112	1	172 200 p.																														
3	365112	1	467 740 p.																														
 <p>203,6 94 181,5h</p> <p>90 200</p> <table border="1"> <tr><td>1</td><td>268804</td><td>1</td><td>3 079 920 p.</td></tr> <tr><td>2</td><td>267418</td><td>1</td><td>1 228 560 p.</td></tr> <tr><td>3</td><td>266310</td><td>1</td><td>293 280 p.</td></tr> <tr><td>4</td><td>260020</td><td>1</td><td>255 480 p.</td></tr> </table>	1	268804	1	3 079 920 p.	2	267418	1	1 228 560 p.	3	266310	1	293 280 p.	4	260020	1	255 480 p.	 <p>203,6 134,4 181,5h</p> <p>90 200</p> <table border="1"> <tr><td>1</td><td>268904</td><td>1</td><td>4 145 760 p.</td></tr> <tr><td>2</td><td>267418</td><td>1</td><td>1 228 560 p.</td></tr> <tr><td>3</td><td>266310</td><td>1</td><td>293 280 p.</td></tr> <tr><td>4</td><td>260020</td><td>1</td><td>255 480 p.</td></tr> </table>	1	268904	1	4 145 760 p.	2	267418	1	1 228 560 p.	3	266310	1	293 280 p.	4	260020	1	255 480 p.
1	268804	1	3 079 920 p.																														
2	267418	1	1 228 560 p.																														
3	266310	1	293 280 p.																														
4	260020	1	255 480 p.																														
1	268904	1	4 145 760 p.																														
2	267418	1	1 228 560 p.																														
3	266310	1	293 280 p.																														
4	260020	1	255 480 p.																														

2-		208,6 94 41,4h	
		90 200	
	() ()		
1	268805 268815	1 .	1 804 440 p.
2	267420 267420	1	541 800 p.
3	260020 260020	1 .	255 480 p.
2-		208,6 134,4 181,5h	
		90 200	
	() ()		
1	268905 268915	1 .	2 775 120 p.
2	267420 267420	1	541 800 p.
3	260020 260020	1 .	255 480 p.
2-		100 1,8 65,6h 150 1,8 65,6h 180 1,8 65,6h	
		58 1,8 28,6h	
	() ()		
	266810 483 600 p.		
	266815 600 360 p.		
	266818 679 200 p.		
	() ()		
	260020 255 480 p.		
2-		44,6 110,5 108,5h	
		1,8 110,5 181,5h	
	() ()		
1	262915	1 .	2 082 480 p.
2	267215	1	468 000 p.
3	265915	1	435 480 p.
3	365915	1	894 600 p.
	() ()		
	266811 716 880 p.		
2-		200 50 72h	
		120 65 74,2h	
	() ()		
1	267514 267515	1 .	776 880 p.
2	267304 267305	1 .	510 120 p.
3	262914	1 .	556 800 p.
4	265114	1	307 080 p.
4	365114	1	907 800 p.
	() ()		
	263401 783 600 p.		
2-		123 62 74,2h	
		123 123 74,2h	
	() ()		
1	267511	1 .	491 640 p.
2	267211	1 .	420 840 p.
	() ()		
1	267204 267205	1 .	373 200 p.
2	267501	1 .	347 400 p.
3	267412	1 .	451 920 p.
		110 20 85,4h	
	() ()		
	266411 1 037 160 p.		

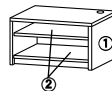
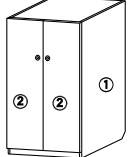
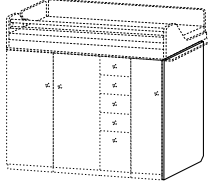
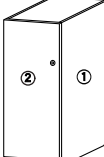
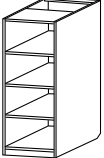
Прайс-лист цены на детскую, молодежную, подростковую мебель СИЛУЭТ (SILUET), 15-08-2013 Софтформ

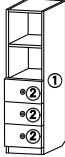
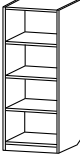
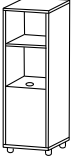

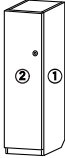
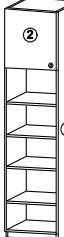
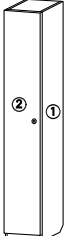
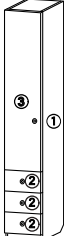
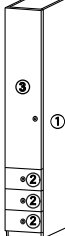
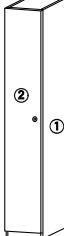
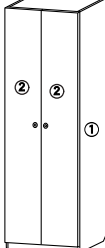
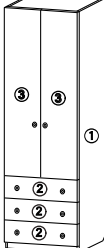

 87,6 50 27,6h  46,6 50 27,6h  87,6 50 27,6h <table border="1" data-bbox="590 302 782 369"> <tr><td>262905</td><td>540 600 p.</td></tr> </table> <table border="1" data-bbox="311 403 782 515"> <tr><td>1</td><td>262903</td><td>1</td><td>698 160 p.</td></tr> <tr><td>2</td><td>265141</td><td>1</td><td>120 000 p.</td></tr> <tr><td>2</td><td>365141</td><td>1</td><td>228 240 p.</td></tr> </table> <table border="1" data-bbox="311 548 782 660"> <tr><td>1</td><td>262904</td><td>1</td><td>1 025 280 p.</td></tr> <tr><td>2</td><td>265182</td><td>1</td><td>161 640 p.</td></tr> <tr><td>2</td><td>365182</td><td>1</td><td>381 480 p.</td></tr> </table>	262905	540 600 p.	1	262903	1	698 160 p.	2	265141	1	120 000 p.	2	365141	1	228 240 p.	1	262904	1	1 025 280 p.	2	265182	1	161 640 p.	2	365182	1	381 480 p.	 41 45 72,4h  82 45 72,4h <table border="1" data-bbox="1021 313 1500 448"> <tr><td>1</td><td>262901</td><td>1</td><td>991 200 p.</td></tr> <tr><td>2</td><td>265141</td><td>3</td><td>120 000 p.</td></tr> <tr><td>2</td><td>365141</td><td>3</td><td>228 240 p.</td></tr> <tr><td>3</td><td>267201</td><td>1</td><td>128 760 p.</td></tr> </table> <table border="1" data-bbox="1021 526 1500 660"> <tr><td>1</td><td>262902</td><td>1</td><td>1 888 080 p.</td></tr> <tr><td>2</td><td>265182</td><td>3</td><td>161 640 p.</td></tr> <tr><td>2</td><td>365182</td><td>3</td><td>381 480 p.</td></tr> <tr><td>3</td><td>267202</td><td>1</td><td>194 400 p.</td></tr> </table>	1	262901	1	991 200 p.	2	265141	3	120 000 p.	2	365141	3	228 240 p.	3	267201	1	128 760 p.	1	262902	1	1 888 080 p.	2	265182	3	161 640 p.	2	365182	3	381 480 p.	3	267202	1	194 400 p.
262905	540 600 p.																																																										
1	262903	1	698 160 p.																																																								
2	265141	1	120 000 p.																																																								
2	365141	1	228 240 p.																																																								
1	262904	1	1 025 280 p.																																																								
2	265182	1	161 640 p.																																																								
2	365182	1	381 480 p.																																																								
1	262901	1	991 200 p.																																																								
2	265141	3	120 000 p.																																																								
2	365141	3	228 240 p.																																																								
3	267201	1	128 760 p.																																																								
1	262902	1	1 888 080 p.																																																								
2	265182	3	161 640 p.																																																								
2	365182	3	381 480 p.																																																								
3	267202	1	194 400 p.																																																								
 41,4 45 30,8h  41,4 45 52,8h  65 32 72,2h <table border="1" data-bbox="311 728 782 862"> <tr><td>1</td><td>262911</td><td>1</td><td>563 400 p.</td></tr> <tr><td>2</td><td>267201</td><td>1</td><td>128 760 p.</td></tr> <tr><td>3</td><td>265141</td><td>1</td><td>120 000 p.</td></tr> <tr><td>3</td><td>365141</td><td>1</td><td>228 240 p.</td></tr> </table> <table border="1" data-bbox="311 873 782 996"> <tr><td>1</td><td>262913</td><td>1</td><td>1 170 000 p.</td></tr> <tr><td>2</td><td>267201</td><td>1</td><td>128 760 p.</td></tr> <tr><td>3</td><td>265142</td><td>3</td><td>85 320 p.</td></tr> <tr><td>3</td><td>365142</td><td>3</td><td>185 160 p.</td></tr> </table> <table border="1" data-bbox="311 1008 782 1108"> <tr><td>1</td><td>266303</td><td>1</td><td>763 080 p.</td></tr> <tr><td>2</td><td>266206</td><td>1</td><td>205 920 p.</td></tr> <tr><td>3</td><td>267408</td><td>1</td><td>165 480 p.</td></tr> </table>	1	262911	1	563 400 p.	2	267201	1	128 760 p.	3	265141	1	120 000 p.	3	365141	1	228 240 p.	1	262913	1	1 170 000 p.	2	267201	1	128 760 p.	3	265142	3	85 320 p.	3	365142	3	185 160 p.	1	266303	1	763 080 p.	2	266206	1	205 920 p.	3	267408	1	165 480 p.	 87,6 50,2 46h <table border="1" data-bbox="1021 1019 1500 1108"> <tr><td>1</td><td>262916</td><td>1</td><td>715 440 p.</td></tr> <tr><td>2</td><td>266101</td><td>1</td><td>264 240 p.</td></tr> </table>	1	262916	1	715 440 p.	2	266101	1	264 240 p.						
1	262911	1	563 400 p.																																																								
2	267201	1	128 760 p.																																																								
3	265141	1	120 000 p.																																																								
3	365141	1	228 240 p.																																																								
1	262913	1	1 170 000 p.																																																								
2	267201	1	128 760 p.																																																								
3	265142	3	85 320 p.																																																								
3	365142	3	185 160 p.																																																								
1	266303	1	763 080 p.																																																								
2	266206	1	205 920 p.																																																								
3	267408	1	165 480 p.																																																								
1	262916	1	715 440 p.																																																								
2	266101	1	264 240 p.																																																								
<p style="text-align: center;">2-</p>  82 94 140,1h  92 1,8 140,1h <table border="1" data-bbox="311 1254 782 1366"> <tr><td>1</td><td>264516</td><td>1</td><td>1 769 640 p.</td></tr> <tr><td>2</td><td>265916</td><td>1</td><td>505 800 p.</td></tr> <tr><td>2</td><td>365916</td><td>1</td><td>1 651 680 p.</td></tr> </table> <table border="1" data-bbox="566 1489 782 1556"> <tr><td>267104</td><td>370 440 p.</td></tr> </table>	1	264516	1	1 769 640 p.	2	265916	1	505 800 p.	2	365916	1	1 651 680 p.	267104	370 440 p.	<p style="text-align: center;">2-</p>  60 94 140,1h  60 92 140,1h <table border="1" data-bbox="933 1265 1500 1377"> <tr><td>1</td><td>264517</td><td>1</td><td>1 591 680 p.</td></tr> <tr><td>2</td><td>265117</td><td>265118</td><td>1 331 200 p.</td></tr> <tr><td>2</td><td>365117</td><td>365118</td><td>1 1 193 640 p.</td></tr> </table> <table border="1" data-bbox="1300 1489 1500 1556"> <tr><td>264165</td><td>1 595 040 p.</td></tr> </table>	1	264517	1	1 591 680 p.	2	265117	265118	1 331 200 p.	2	365117	365118	1 1 193 640 p.	264165	1 595 040 p.																														
1	264516	1	1 769 640 p.																																																								
2	265916	1	505 800 p.																																																								
2	365916	1	1 651 680 p.																																																								
267104	370 440 p.																																																										
1	264517	1	1 591 680 p.																																																								
2	265117	265118	1 331 200 p.																																																								
2	365117	365118	1 1 193 640 p.																																																								
264165	1 595 040 p.																																																										
<p style="text-align: center;">2-</p>  41 45 140,1h  41 45 140,1h <table border="1" data-bbox="311 1657 782 1825"> <tr><td>1</td><td>264519</td><td>1</td><td>1 619 760 p.</td></tr> <tr><td>2</td><td>265141</td><td>4</td><td>120 000 p.</td></tr> <tr><td>2</td><td>365141</td><td>4</td><td>228 240 p.</td></tr> <tr><td>3</td><td>265143</td><td>1</td><td>137 880 p.</td></tr> <tr><td>3</td><td>365143</td><td>1</td><td>368 880 p.</td></tr> </table> <table border="1" data-bbox="311 1881 782 2004"> <tr><td>1</td><td>264520</td><td>1</td><td>1 360 560 p.</td></tr> <tr><td>2</td><td>265141</td><td>3</td><td>120 000 p.</td></tr> <tr><td>2</td><td>365141</td><td>3</td><td>228 240 p.</td></tr> </table>	1	264519	1	1 619 760 p.	2	265141	4	120 000 p.	2	365141	4	228 240 p.	3	265143	1	137 880 p.	3	365143	1	368 880 p.	1	264520	1	1 360 560 p.	2	265141	3	120 000 p.	2	365141	3	228 240 p.	<p style="text-align: center;">2-</p>  60 43 140,1h  49 41 140,1h <table border="1" data-bbox="1260 1702 1500 1780"> <tr><td>264164</td><td>1 142 040 p.</td></tr> </table> <table border="1" data-bbox="1260 1926 1500 2004"> <tr><td>264223</td><td>993 480 p.</td></tr> </table>	264164	1 142 040 p.	264223	993 480 p.																						
1	264519	1	1 619 760 p.																																																								
2	265141	4	120 000 p.																																																								
2	365141	4	228 240 p.																																																								
3	265143	1	137 880 p.																																																								
3	365143	1	368 880 p.																																																								
1	264520	1	1 360 560 p.																																																								
2	265141	3	120 000 p.																																																								
2	365141	3	228 240 p.																																																								
264164	1 142 040 p.																																																										
264223	993 480 p.																																																										

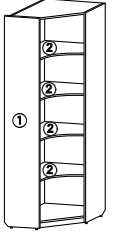
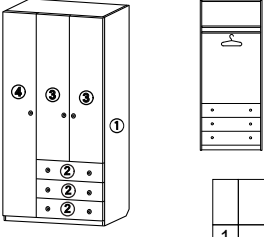
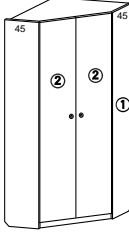
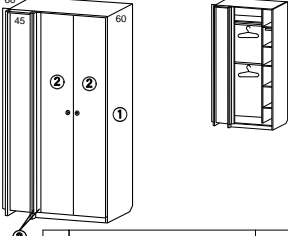
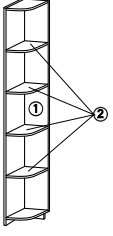
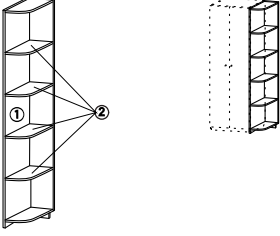
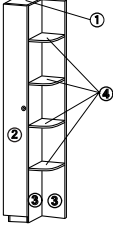
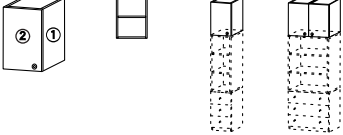

Прайс-лист цены на детскую, молодежную, подростковую мебель СИЛУЭТ (SILUET), 15-08-2013 Софтформ

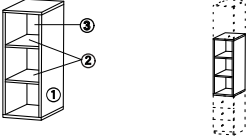
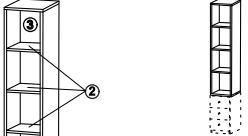
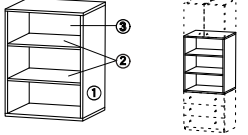
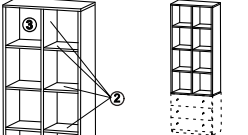
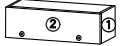
		2-													
		41 45 140,1h				60 45 235,6h									
1		264144		1	.	1 080 600 p.		1	.	1 753 440 p.					
2		265119	265120	1	.	263 760 p.		2	.	265105	265106	1	.	189 000 p.	
2		365119	365120	1	.	898 920 p.		2	.	365105	365106	1	.	609 120 p.	
		41 45 235,6h				41 45 235,6h									
1		264101		1	.	1 515 480 p.		1	.	264102		1	.	1 819 200 p.	
2		265102		1	.	419 160 p.		2	.	265141		3	.	120 000 p.	
2		365102		1	.	1 352 880 p.		2	.	365141		3	.	228 240 p.	
								3	.	265103	265104	1	.	309 840 p.	
								3	.	365103	365104	1	.	1 057 320 p.	
		41 60 235,6h				41 60 235,6h									
1		264105		1	.	1 937 040 p.		1	.	264104		1	.	1 501 080 p.	
2		265141		3	.	120 000 p.		2	.	265102		1	.	419 160 p.	
2		365141		3	.	228 240 p.		2	.	365102		1	.	1 352 880 p.	
3		265103	265104	1	.	309 840 p.									
3		365103	365104	1	.	1 057 320 p.									
		82 60 235,6h				82 60 235,6h									
1		264106		1	.	1 894 080 p.		1	.	264107		1	.	3 135 600 p.	
2		265901		1	.	775 800 p.		2	.	265182		3	.	161 640 p.	
2		365901		1	.	2 666 880 p.		2	.	365182		3	.	341 480 p.	
								3	.	265903		1	.	591 840 p.	
								3	.	365903		1	.	1 971 120 p.	

 <p>80 80 235,6h</p> <table border="1" data-bbox="311 571 790 660"> <tr> <td>1</td> <td>264111</td> <td>1</td> <td>2 048 400 p.</td> </tr> <tr> <td>2</td> <td>266211</td> <td>1</td> <td>693 000 p.</td> </tr> </table>	1	264111	1	2 048 400 p.	2	266211	1	693 000 p.	 <p>123 60 235,6h</p> <table border="1" data-bbox="1021 459 1500 660"> <tr> <td>1</td> <td>264108</td> <td>1</td> <td>4 180 320 p.</td> </tr> <tr> <td>2</td> <td>265182</td> <td>3</td> <td>161 640 p.</td> </tr> <tr> <td>2</td> <td>365182</td> <td>3</td> <td>381 480 p.</td> </tr> <tr> <td>3</td> <td>265903</td> <td>1</td> <td>591 840 p.</td> </tr> <tr> <td>3</td> <td>365903</td> <td>1</td> <td>1 971 120 p.</td> </tr> <tr> <td>4</td> <td>265102</td> <td>1</td> <td>419 160 p.</td> </tr> <tr> <td>4</td> <td>365102</td> <td>1</td> <td>1 352 880 p.</td> </tr> </table>	1	264108	1	4 180 320 p.	2	265182	3	161 640 p.	2	365182	3	381 480 p.	3	265903	1	591 840 p.	3	365903	1	1 971 120 p.	4	265102	1	419 160 p.	4	365102	1	1 352 880 p.	
1	264111	1	2 048 400 p.																																			
2	266211	1	693 000 p.																																			
1	264108	1	4 180 320 p.																																			
2	265182	3	161 640 p.																																			
2	365182	3	381 480 p.																																			
3	265903	1	591 840 p.																																			
3	365903	1	1 971 120 p.																																			
4	265102	1	419 160 p.																																			
4	365102	1	1 352 880 p.																																			
 <p>102,8 102,8 235,6h</p> <table border="1" data-bbox="311 996 790 1108"> <tr> <td>1</td> <td>264109</td> <td>1</td> <td>3 329 040 p.</td> </tr> <tr> <td>2</td> <td>265901</td> <td>1</td> <td>775 800 p.</td> </tr> <tr> <td>2</td> <td>365901</td> <td>1</td> <td>2 666 880 p.</td> </tr> </table>	1	264109	1	3 329 040 p.	2	265901	1	775 800 p.	2	365901	1	2 666 880 p.	 <p>133 66 235,6h</p> <table border="1" data-bbox="853 952 1500 1108"> <tr> <td>1</td> <td>264511</td> <td>264512</td> <td>1</td> <td>3 758 160 p.</td> </tr> <tr> <td>2</td> <td>265901</td> <td></td> <td>1</td> <td>775 800 p.</td> </tr> <tr> <td>2</td> <td>365901</td> <td></td> <td>1</td> <td>2 666 880 p.</td> </tr> <tr> <td>3</td> <td>260010</td> <td></td> <td>1</td> <td>354 600 p.</td> </tr> <tr> <td>3</td> <td>360010</td> <td></td> <td>1</td> <td>833 400 p.</td> </tr> </table>	1	264511	264512	1	3 758 160 p.	2	265901		1	775 800 p.	2	365901		1	2 666 880 p.	3	260010		1	354 600 p.	3	360010		1	833 400 p.
1	264109	1	3 329 040 p.																																			
2	265901	1	775 800 p.																																			
2	365901	1	2 666 880 p.																																			
1	264511	264512	1	3 758 160 p.																																		
2	265901		1	775 800 p.																																		
2	365901		1	2 666 880 p.																																		
3	260010		1	354 600 p.																																		
3	360010		1	833 400 p.																																		
 <p>30 43 235,6h</p> <table border="1" data-bbox="143 1467 790 1556"> <tr> <td>1</td> <td>267101</td> <td>267101</td> <td>1</td> <td>619 920 p.</td> </tr> <tr> <td>2</td> <td>266202</td> <td>266203</td> <td>1</td> <td>652 800 p.</td> </tr> </table>	1	267101	267101	1	619 920 p.	2	266202	266203	1	652 800 p.	 <p>30 58 235,6h</p> <table border="1" data-bbox="853 1467 1500 1556"> <tr> <td>1</td> <td>267102</td> <td>267102</td> <td>1</td> <td>676 680 p.</td> </tr> <tr> <td>2</td> <td>266204</td> <td>266205</td> <td>1</td> <td>799 320 p.</td> </tr> </table>	1	267102	267102	1	676 680 p.	2	266204	266205	1	799 320 p.																	
1	267101	267101	1	619 920 p.																																		
2	266202	266203	1	652 800 p.																																		
1	267102	267102	1	676 680 p.																																		
2	266204	266205	1	799 320 p.																																		
 <p>60 30 235,6h</p> <table border="1" data-bbox="311 1848 790 2004"> <tr> <td>1</td> <td>264110</td> <td>1</td> <td>1 141 680 p.</td> </tr> <tr> <td>2</td> <td>265101</td> <td>1</td> <td>357 000 p.</td> </tr> <tr> <td>2</td> <td>365101</td> <td>1</td> <td>1 162 200 p.</td> </tr> <tr> <td>3</td> <td>264311</td> <td>1</td> <td>680 520 p.</td> </tr> <tr> <td>4</td> <td>266201</td> <td>1</td> <td>340 080 p.</td> </tr> </table>	1	264110	1	1 141 680 p.	2	265101	1	357 000 p.	2	365101	1	1 162 200 p.	3	264311	1	680 520 p.	4	266201	1	340 080 p.	 <p>41 45 60h</p> <table border="1" data-bbox="853 1892 1500 2004"> <tr> <td>1</td> <td>266301</td> <td>266301</td> <td>1</td> <td>588 120 p.</td> </tr> <tr> <td>2</td> <td>265107</td> <td>265108</td> <td>1</td> <td>158 160 p.</td> </tr> <tr> <td>2</td> <td>365107</td> <td>365108</td> <td>1</td> <td>453 720 p.</td> </tr> </table>	1	266301	266301	1	588 120 p.	2	265107	265108	1	158 160 p.	2	365107	365108	1	453 720 p.		
1	264110	1	1 141 680 p.																																			
2	265101	1	357 000 p.																																			
2	365101	1	1 162 200 p.																																			
3	264311	1	680 520 p.																																			
4	266201	1	340 080 p.																																			
1	266301	266301	1	588 120 p.																																		
2	265107	265108	1	158 160 p.																																		
2	365107	365108	1	453 720 p.																																		

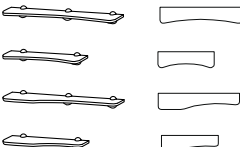
Прайс-лист цены на детскую, молодежную, подростковую мебель СИЛУЭТ (SILUET), 15-08-2013 Софтформ

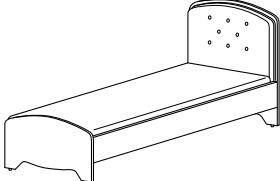
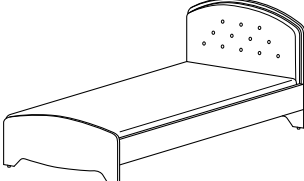
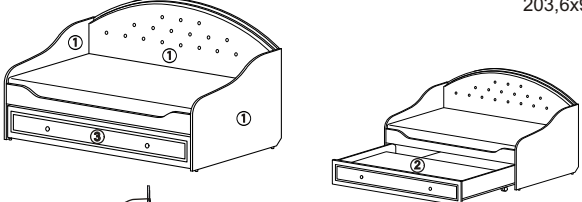
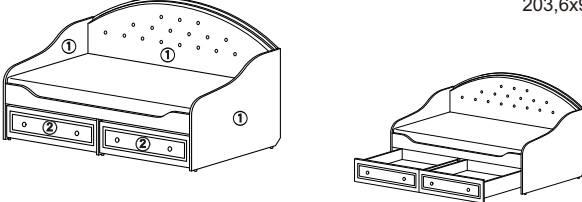
 <p style="text-align: right;">41 45 103,2h</p> <p style="text-align: center;">()</p> <table border="1" data-bbox="311 548 782 660"> <tr><td>1</td><td>267531</td><td>1</td><td>.</td><td>717 000 p.</td></tr> <tr><td>2</td><td>266131</td><td>1</td><td>.</td><td>161 160 p.</td></tr> <tr><td>3</td><td>267401</td><td>1</td><td>.</td><td>125 040 p.</td></tr> </table>	1	267531	1	.	717 000 p.	2	266131	1	.	161 160 p.	3	267401	1	.	125 040 p.	 <p style="text-align: right;">41 30 161,4h</p> <p style="text-align: center;">()</p> <table border="1" data-bbox="1021 548 1492 660"> <tr><td>1</td><td>267541</td><td>1</td><td>.</td><td>802 920 p.</td></tr> <tr><td>2</td><td>266141</td><td>1</td><td>.</td><td>212 400 p.</td></tr> <tr><td>3</td><td>267403</td><td>1</td><td>.</td><td>180 240 p.</td></tr> </table>	1	267541	1	.	802 920 p.	2	266141	1	.	212 400 p.	3	267403	1	.	180 240 p.					
1	267531	1	.	717 000 p.																																
2	266131	1	.	161 160 p.																																
3	267401	1	.	125 040 p.																																
1	267541	1	.	802 920 p.																																
2	266141	1	.	212 400 p.																																
3	267403	1	.	180 240 p.																																
 <p style="text-align: right;">82 45 103,2h</p> <p style="text-align: center;">()</p> <table border="1" data-bbox="311 996 782 1108"> <tr><td>1</td><td>267532</td><td>1</td><td>.</td><td>860 880 p.</td></tr> <tr><td>2</td><td>266132</td><td>1</td><td>.</td><td>264 000 p.</td></tr> <tr><td>3</td><td>267402</td><td>1</td><td>.</td><td>217 560 p.</td></tr> </table>	1	267532	1	.	860 880 p.	2	266132	1	.	264 000 p.	3	267402	1	.	217 560 p.	 <p style="text-align: right;">82 30 161,4h</p> <p style="text-align: center;">()</p> <table border="1" data-bbox="1021 996 1492 1108"> <tr><td>1</td><td>267542</td><td>1</td><td>.</td><td>914 760 p.</td></tr> <tr><td>2</td><td>266142</td><td>1</td><td>.</td><td>569 640 p.</td></tr> <tr><td>3</td><td>267404</td><td>1</td><td>.</td><td>318 480 p.</td></tr> </table>	1	267542	1	.	914 760 p.	2	266142	1	.	569 640 p.	3	267404	1	.	318 480 p.					
1	267532	1	.	860 880 p.																																
2	266132	1	.	264 000 p.																																
3	267402	1	.	217 560 p.																																
1	267542	1	.	914 760 p.																																
2	266142	1	.	569 640 p.																																
3	267404	1	.	318 480 p.																																
 <p style="text-align: right;">102 29 30h</p> <table border="1" data-bbox="311 1444 782 1556"> <tr><td>1</td><td>266305</td><td>1</td><td>.</td><td>842 760 .</td></tr> <tr><td>2</td><td>265109</td><td>1</td><td>.</td><td>182 880 p.</td></tr> <tr><td>2</td><td>365109</td><td>1</td><td>.</td><td>558 360 p.</td></tr> </table>	1	266305	1	.	842 760 .	2	265109	1	.	182 880 p.	2	365109	1	.	558 360 p.	 <p style="text-align: right;">51 29 60h</p> <table border="1" data-bbox="853 1444 1492 1556"> <tr><td></td><td>()</td><td>()</td><td></td><td></td></tr> <tr><td>1</td><td>266306</td><td>266306</td><td>1</td><td>681 240 p.</td></tr> <tr><td>2</td><td>265111</td><td>265110</td><td>1</td><td>172 920 p.</td></tr> <tr><td>2</td><td>365111</td><td>365110</td><td>1</td><td>531 240 p.</td></tr> </table>		()	()			1	266306	266306	1	681 240 p.	2	265111	265110	1	172 920 p.	2	365111	365110	1	531 240 p.
1	266305	1	.	842 760 .																																
2	265109	1	.	182 880 p.																																
2	365109	1	.	558 360 p.																																
	()	()																																		
1	266306	266306	1	681 240 p.																																
2	265111	265110	1	172 920 p.																																
2	365111	365110	1	531 240 p.																																
 <p style="text-align: right;">102 27 30h</p> <table border="1" data-bbox="311 1691 782 1780"> <tr><td>1</td><td>266304</td><td>1</td><td>.</td><td>679 920 p.</td></tr> <tr><td>2</td><td>267411</td><td>1</td><td>.</td><td>101 640 p.</td></tr> </table> <p style="text-align: right;">65 32 65h</p>  <table border="1" data-bbox="311 1892 782 2004"> <tr><td>1</td><td>266302</td><td>1</td><td>.</td><td>659 160 p.</td></tr> <tr><td>2</td><td>266206</td><td>1</td><td>.</td><td>205 920 p.</td></tr> <tr><td>3</td><td>267405</td><td>1</td><td>.</td><td>163 920 p.</td></tr> </table>	1	266304	1	.	679 920 p.	2	267411	1	.	101 640 p.	1	266302	1	.	659 160 p.	2	266206	1	.	205 920 p.	3	267405	1	.	163 920 p.	 <p style="text-align: right;">120 25 1,8h 82 25 1,8h 120 25 1,8h 82 25 1,8h</p> <table border="1" data-bbox="1260 1702 1492 1848"> <tr><td>266403</td><td>429 480 p.</td></tr> <tr><td>266404</td><td>307 200 p.</td></tr> <tr><td>266405</td><td>425 160 p.</td></tr> <tr><td>266406</td><td>303 720 p.</td></tr> </table> <p style="text-align: right;">69,4 1,8 110h</p> <table border="1" data-bbox="1260 1926 1492 2004"> <tr><td>260030</td><td>1 450 320 p.</td></tr> </table>	266403	429 480 p.	266404	307 200 p.	266405	425 160 p.	266406	303 720 p.	260030	1 450 320 p.
1	266304	1	.	679 920 p.																																
2	267411	1	.	101 640 p.																																
1	266302	1	.	659 160 p.																																
2	266206	1	.	205 920 p.																																
3	267405	1	.	163 920 p.																																
266403	429 480 p.																																			
266404	307 200 p.																																			
266405	425 160 p.																																			
266406	303 720 p.																																			
260030	1 450 320 p.																																			

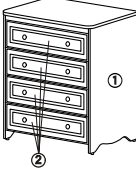
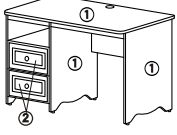
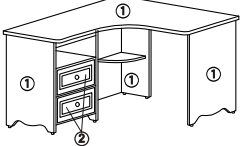
Кровать без матраса		Кровать без матраса																																				
	209,1x95,4x95,3h		209,1x125,4x95,3h																																			
ортопедическое основание, место под матрас размером 90x200		ортопедическое основание, место под матрас размером 120x200																																				
<table border="1"> <thead> <tr> <th>артикул</th> <th>цена за единицу</th> </tr> </thead> <tbody> <tr> <td>318601</td> <td>4 148 400 р.</td> </tr> </tbody> </table>	артикул	цена за единицу	318601	4 148 400 р.		<table border="1"> <thead> <tr> <th>артикул</th> <th>цена за единицу</th> </tr> </thead> <tbody> <tr> <td>318602</td> <td>5 672 280 р.</td> </tr> </tbody> </table>	артикул	цена за единицу	318602	5 672 280 р.																												
артикул	цена за единицу																																					
318601	4 148 400 р.																																					
артикул	цена за единицу																																					
318602	5 672 280 р.																																					
Тахта без матраса с выдвижной кроватью		Тахта без матраса с выдвижными ящиками																																				
	203,6x99,7x104,4h		203,6x99,7x104,4h																																			
верхнее спальное место под матрас размером 90x200, нижнее спальное место под матрас размером 80x190		место под матрас размером 90x200																																				
<table border="1"> <thead> <tr> <th>№</th> <th>наименование</th> <th>артикул</th> <th>количество в изделии</th> <th>цена за единицу</th> </tr> </thead> <tbody> <tr> <td>1</td> <td>каркас кровати</td> <td>318605</td> <td>1шт.</td> <td>5 224 800 р.</td> </tr> <tr> <td>2</td> <td>кровать выдвижная</td> <td>318806</td> <td>1шт.</td> <td>1 249 560 р.</td> </tr> <tr> <td>3</td> <td>фасад</td> <td>315806</td> <td>1шт.</td> <td>652 920 р.</td> </tr> </tbody> </table>	№	наименование	артикул	количество в изделии	цена за единицу	1	каркас кровати	318605	1шт.	5 224 800 р.	2	кровать выдвижная	318806	1шт.	1 249 560 р.	3	фасад	315806	1шт.	652 920 р.		<table border="1"> <thead> <tr> <th>№</th> <th>наименование</th> <th>артикул</th> <th>количество в изделии</th> <th>цена за единицу</th> </tr> </thead> <tbody> <tr> <td>1</td> <td>каркас кровати</td> <td>318803</td> <td>1шт.</td> <td>6 396 600 р.</td> </tr> <tr> <td>2</td> <td>фасад</td> <td>315903</td> <td>1 комплект</td> <td>978 960 р.</td> </tr> </tbody> </table>	№	наименование	артикул	количество в изделии	цена за единицу	1	каркас кровати	318803	1шт.	6 396 600 р.	2	фасад	315903	1 комплект	978 960 р.	
№	наименование	артикул	количество в изделии	цена за единицу																																		
1	каркас кровати	318605	1шт.	5 224 800 р.																																		
2	кровать выдвижная	318806	1шт.	1 249 560 р.																																		
3	фасад	315806	1шт.	652 920 р.																																		
№	наименование	артикул	количество в изделии	цена за единицу																																		
1	каркас кровати	318803	1шт.	6 396 600 р.																																		
2	фасад	315903	1 комплект	978 960 р.																																		
Тумба прикроватная		Комод																																				
	51,6x55x58,8h		96,6x55x103,2h																																			
<table border="1"> <thead> <tr> <th>№</th> <th>наименование</th> <th>артикул</th> <th>количество в изделии</th> <th>цена за единицу</th> </tr> </thead> <tbody> <tr> <td>1</td> <td>каркас тумбы</td> <td>312902</td> <td>1шт.</td> <td>1 410 600 р.</td> </tr> <tr> <td>2</td> <td>фасад</td> <td>315852</td> <td>1 комплект</td> <td>767 160 р.</td> </tr> </tbody> </table>	№	наименование	артикул	количество в изделии	цена за единицу	1	каркас тумбы	312902	1шт.	1 410 600 р.	2	фасад	315852	1 комплект	767 160 р.		<table border="1"> <thead> <tr> <th>№</th> <th>наименование</th> <th>артикул</th> <th>количество в изделии</th> <th>цена за единицу</th> </tr> </thead> <tbody> <tr> <td>1</td> <td>каркас комода</td> <td>312901</td> <td>1шт.</td> <td>3 073 440 р.</td> </tr> <tr> <td>2</td> <td>фасад</td> <td>315894</td> <td>1 комплект</td> <td>1 808 040 р.</td> </tr> </tbody> </table>	№	наименование	артикул	количество в изделии	цена за единицу	1	каркас комода	312901	1шт.	3 073 440 р.	2	фасад	315894	1 комплект	1 808 040 р.						
№	наименование	артикул	количество в изделии	цена за единицу																																		
1	каркас тумбы	312902	1шт.	1 410 600 р.																																		
2	фасад	315852	1 комплект	767 160 р.																																		
№	наименование	артикул	количество в изделии	цена за единицу																																		
1	каркас комода	312901	1шт.	3 073 440 р.																																		
2	фасад	315894	1 комплект	1 808 040 р.																																		
Стол письменный		Стол угловой																																				
	130x60x76h		130x130x76h																																			
<table border="1"> <thead> <tr> <th>№</th> <th>наименование</th> <th>артикул (изображено)</th> <th>артикул (зеркально)</th> <th>количество в изделии</th> <th>цена за единицу</th> </tr> </thead> <tbody> <tr> <td>1</td> <td>каркас стола</td> <td>311901</td> <td>311911</td> <td>1шт.</td> <td>2 236 200 р.</td> </tr> <tr> <td>2</td> <td>фасад</td> <td colspan="2">315852</td> <td>1 комплект</td> <td>767 160 р.</td> </tr> </tbody> </table>	№	наименование	артикул (изображено)	артикул (зеркально)	количество в изделии	цена за единицу	1	каркас стола	311901	311911	1шт.	2 236 200 р.	2	фасад	315852		1 комплект	767 160 р.		<table border="1"> <thead> <tr> <th>№</th> <th>наименование</th> <th>артикул (зеркально)</th> <th>количество в изделии</th> <th>цена за единицу</th> </tr> </thead> <tbody> <tr> <td>1</td> <td>каркас стола</td> <td>311902</td> <td>311912</td> <td>1шт.</td> <td>2 759 880 р.</td> </tr> <tr> <td>2</td> <td>фасад</td> <td colspan="2">315852</td> <td>1 комплект</td> <td>767 160 р.</td> </tr> </tbody> </table>	№	наименование	артикул (зеркально)	количество в изделии	цена за единицу	1	каркас стола	311902	311912	1шт.	2 759 880 р.	2	фасад	315852		1 комплект	767 160 р.	
№	наименование	артикул (изображено)	артикул (зеркально)	количество в изделии	цена за единицу																																	
1	каркас стола	311901	311911	1шт.	2 236 200 р.																																	
2	фасад	315852		1 комплект	767 160 р.																																	
№	наименование	артикул (зеркально)	количество в изделии	цена за единицу																																		
1	каркас стола	311902	311912	1шт.	2 759 880 р.																																	
2	фасад	315852		1 комплект	767 160 р.																																	

Все цены указаны с НДС.

Основной цвет: гасиенда

Дополнительные цвета: капучино, пастель

Прайс-лист цены на детскую, молодежную, подростковую мебель **СТРЕКОЗА**, 11-02-2013 Софтформ

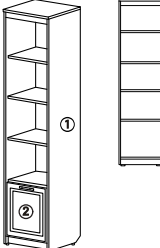
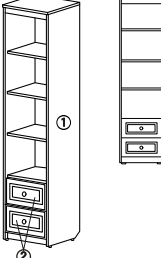
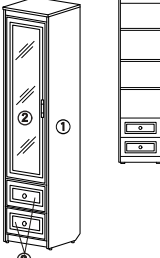
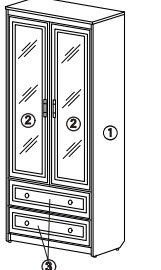
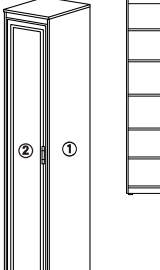
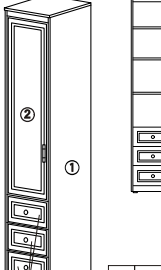
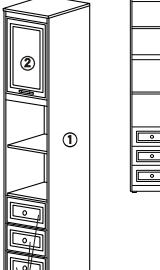
Полки настольные		Шкаф																																											
 <p>61,8x61,8x60h</p> <table border="1"> <tr> <th>артикул</th> <th>цена за единицу</th> </tr> <tr> <td>316401</td> <td>612 720 р.</td> </tr> </table> <p>92x26,8x29,2h</p> <table border="1"> <tr> <th>артикул</th> <th>цена за единицу</th> </tr> <tr> <td>316402</td> <td>1 078 440 р.</td> </tr> </table>	артикул	цена за единицу	316401	612 720 р.	артикул	цена за единицу	316402	1 078 440 р.	 <p>48,8x36x189,2h</p> <table border="1"> <tr> <th>№</th> <th>наименование</th> <th>артикул</th> <th>количество в изделии</th> <th>цена за единицу</th> </tr> <tr> <td>1</td> <td>каркас шкафа</td> <td>314109</td> <td>1шт.</td> <td>2 152 320 р.</td> </tr> <tr> <td>2</td> <td>дверь</td> <td>315854</td> <td>1шт.</td> <td>372 360 р.</td> </tr> </table>	№	наименование	артикул	количество в изделии	цена за единицу	1	каркас шкафа	314109	1шт.	2 152 320 р.	2	дверь	315854	1шт.	372 360 р.																					
артикул	цена за единицу																																												
316401	612 720 р.																																												
артикул	цена за единицу																																												
316402	1 078 440 р.																																												
№	наименование	артикул	количество в изделии	цена за единицу																																									
1	каркас шкафа	314109	1шт.	2 152 320 р.																																									
2	дверь	315854	1шт.	372 360 р.																																									
Шкаф		Шкаф																																											
 <p>48,8x36x189,2h</p> <table border="1"> <tr> <th>№</th> <th>наименование</th> <th>артикул</th> <th>количество в изделии</th> <th>цена за единицу</th> </tr> <tr> <td>1</td> <td>каркас шкафа</td> <td>314116</td> <td>1шт.</td> <td>2 580 240 р.</td> </tr> <tr> <td>2</td> <td>фасад</td> <td>315852</td> <td>1 комплект</td> <td>767 160 р.</td> </tr> </table>	№	наименование	артикул	количество в изделии	цена за единицу	1	каркас шкафа	314116	1шт.	2 580 240 р.	2	фасад	315852	1 комплект	767 160 р.	 <p>48,8x36x189,2h</p> <p>прозрачное стекло в раме из МДФ</p> <table border="1"> <tr> <th>№</th> <th>наименование</th> <th>артикул (изображено)</th> <th>артикул (зеркально)</th> <th>количество в изделии</th> <th>цена за единицу</th> </tr> <tr> <td>1</td> <td>каркас шкафа</td> <td>314111</td> <td></td> <td>1шт.</td> <td>2 724 600 р.</td> </tr> <tr> <td>2</td> <td>дверь</td> <td>315402</td> <td>315403</td> <td>1шт.</td> <td>781 200 р.</td> </tr> <tr> <td>3</td> <td>фасад</td> <td>315852</td> <td></td> <td>1 комплект</td> <td>767 160 р.</td> </tr> </table>	№	наименование	артикул (изображено)	артикул (зеркально)	количество в изделии	цена за единицу	1	каркас шкафа	314111		1шт.	2 724 600 р.	2	дверь	315402	315403	1шт.	781 200 р.	3	фасад	315852		1 комплект	767 160 р.					
№	наименование	артикул	количество в изделии	цена за единицу																																									
1	каркас шкафа	314116	1шт.	2 580 240 р.																																									
2	фасад	315852	1 комплект	767 160 р.																																									
№	наименование	артикул (изображено)	артикул (зеркально)	количество в изделии	цена за единицу																																								
1	каркас шкафа	314111		1шт.	2 724 600 р.																																								
2	дверь	315402	315403	1шт.	781 200 р.																																								
3	фасад	315852		1 комплект	767 160 р.																																								
Шкаф		Шкаф																																											
 <p>93,8x36x189,2h</p> <p>прозрачное стекло в раме из МДФ</p> <table border="1"> <tr> <th>№</th> <th>наименование</th> <th>артикул</th> <th>количество в изделии</th> <th>цена за единицу</th> </tr> <tr> <td>1</td> <td>каркас шкафа</td> <td>314114</td> <td>1шт.</td> <td>3 742 560 р.</td> </tr> <tr> <td>2</td> <td>дверь</td> <td>315422</td> <td>1 комплект</td> <td>1 544 160 р.</td> </tr> <tr> <td>3</td> <td>фасад</td> <td>315892</td> <td>1 комплект</td> <td>907 080 р.</td> </tr> </table>	№	наименование	артикул	количество в изделии	цена за единицу	1	каркас шкафа	314114	1шт.	3 742 560 р.	2	дверь	315422	1 комплект	1 544 160 р.	3	фасад	315892	1 комплект	907 080 р.	 <p>48,8x46x224h</p> <table border="1"> <tr> <th>№</th> <th>наименование</th> <th>артикул</th> <th>количество в изделии</th> <th>цена за единицу</th> </tr> <tr> <td>1</td> <td>каркас шкафа</td> <td>314101</td> <td>1шт.</td> <td>2 380 560 р.</td> </tr> <tr> <td>2</td> <td>дверь</td> <td>315801</td> <td>1шт.</td> <td>746 520 р.</td> </tr> </table>	№	наименование	артикул	количество в изделии	цена за единицу	1	каркас шкафа	314101	1шт.	2 380 560 р.	2	дверь	315801	1шт.	746 520 р.									
№	наименование	артикул	количество в изделии	цена за единицу																																									
1	каркас шкафа	314114	1шт.	3 742 560 р.																																									
2	дверь	315422	1 комплект	1 544 160 р.																																									
3	фасад	315892	1 комплект	907 080 р.																																									
№	наименование	артикул	количество в изделии	цена за единицу																																									
1	каркас шкафа	314101	1шт.	2 380 560 р.																																									
2	дверь	315801	1шт.	746 520 р.																																									
Шкаф		Шкаф																																											
 <p>48,8x46x224h</p> <table border="1"> <tr> <th>№</th> <th>наименование</th> <th>артикул (изображено)</th> <th>артикул (зеркально)</th> <th>количество в изделии</th> <th>цена за единицу</th> </tr> <tr> <td>1</td> <td>каркас шкафа</td> <td>314102</td> <td></td> <td>1шт.</td> <td>3 218 160 р.</td> </tr> <tr> <td>2</td> <td>дверь</td> <td>315802</td> <td>315803</td> <td>1шт.</td> <td>594 240 р.</td> </tr> <tr> <td>3</td> <td>фасад</td> <td>315853</td> <td></td> <td>1 комплект</td> <td>1 141 920 р.</td> </tr> </table>	№	наименование	артикул (изображено)	артикул (зеркально)	количество в изделии	цена за единицу	1	каркас шкафа	314102		1шт.	3 218 160 р.	2	дверь	315802	315803	1шт.	594 240 р.	3	фасад	315853		1 комплект	1 141 920 р.	 <p>48,8x46x224h</p> <table border="1"> <tr> <th>№</th> <th>наименование</th> <th>артикул</th> <th>количество в изделии</th> <th>цена за единицу</th> </tr> <tr> <td>1</td> <td>каркас шкафа</td> <td>314103</td> <td>1шт.</td> <td>3 315 120 р.</td> </tr> <tr> <td>2</td> <td>дверь</td> <td>315804</td> <td>1шт.</td> <td>424 440 р.</td> </tr> <tr> <td>3</td> <td>фасад</td> <td>315853</td> <td>1 комплект</td> <td>1 141 920 р.</td> </tr> </table>	№	наименование	артикул	количество в изделии	цена за единицу	1	каркас шкафа	314103	1шт.	3 315 120 р.	2	дверь	315804	1шт.	424 440 р.	3	фасад	315853	1 комплект	1 141 920 р.
№	наименование	артикул (изображено)	артикул (зеркально)	количество в изделии	цена за единицу																																								
1	каркас шкафа	314102		1шт.	3 218 160 р.																																								
2	дверь	315802	315803	1шт.	594 240 р.																																								
3	фасад	315853		1 комплект	1 141 920 р.																																								
№	наименование	артикул	количество в изделии	цена за единицу																																									
1	каркас шкафа	314103	1шт.	3 315 120 р.																																									
2	дверь	315804	1шт.	424 440 р.																																									
3	фасад	315853	1 комплект	1 141 920 р.																																									

Все цены указаны с НДС.

Основной цвет: гасиенда



Дополнительные цвета: капучино, пастель

Шкаф-гардероб					Шкаф-гардероб					
<p>48,8x61x224h</p>					<p>48,8x61x224h</p>					
№	наименование	артикул	количество в изделии	цена за единицу	№	наименование	артикул (изображено)	артикул (зеркально)	количество в изделии	цена за единицу
1	каркас шкафа	314104	1шт.	2 346 240 р.	1	каркас шкафа	314105		1шт.	3 309 360 р.
2	дверь	315801	1шт.	746 520 р.	2	дверь	315802	315803	1шт.	594 240 р.
					3	фасад	315853		1 комплект	1 141 920 р.
Шкаф-гардероб					Шкаф-гардероб угловой					
<p>93,8x61x224h</p>					<p>110x110x224h</p>					
№	наименование	артикул	количество в изделии	цена за единицу	№	наименование	артикул	количество в изделии	цена за единицу	
1	каркас шкафа	314106	1шт.	4 280 160 р.	1	каркас шкафа	314108	1шт.	4 794 840 р.	
2	дверь	315822	1 комплект	1 165 200 р.	2	дверь	315811	1 комплект	1 470 600 р.	
3	фасад	315893	1 комплект	1 407 120 р.						
Шкаф-гардероб										
<p>138,8x61x224h</p>										
№	наименование	артикул (изображено)	артикул (зеркально)	количество в изделии	цена за единицу					
1	каркас шкафа	314107	314117	1шт.	5 656 920 р.					
2	дверь	315801		1шт.	746 520 р.					
3	дверь	315822		1 комплект	1 165 200 р.					
4	фасад	315893		1 комплект	1 407 120 р.					
Стеллаж-окончание					Шкаф-окончание					
<p>30x45,4x222,2h</p>					<p>33,4x60,4x224h</p>					
применяется со шкафами глубиной 46см.					применяется со шкафами глубиной 61см.					
артикул (изображено)	артикул (зеркально)	цена за единицу			№	наименование	артикул (изображено)	артикул (зеркально)	количество в изделии	цена за единицу
314301	314302	1 474 080 р.			1	каркас шкафа	314113	314112	1шт.	2 922 720 р.
					2	дверь	315833		1 комплект	864 000 р.

Все цены указаны с НДС.



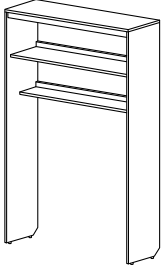
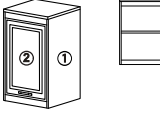
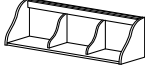
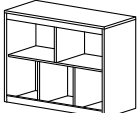



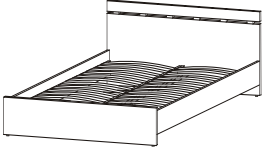
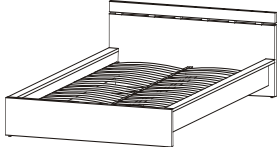
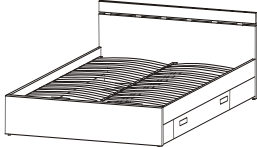
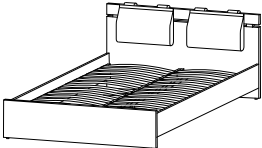
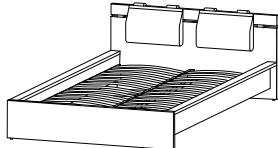
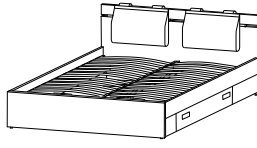

Основной цвет: гасиенда

Дополнительные цвета: капучино, пастель

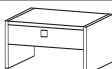

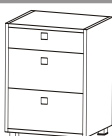

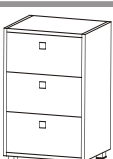

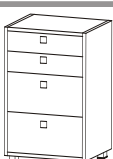

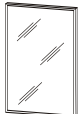
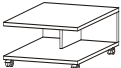

Стеллаж	Шкаф навесной																			
 <p>133,8x36x189,2h</p> <table border="1" data-bbox="550 593 782 660"> <thead> <tr> <th>артикул</th> <th>Цена за единицу</th> </tr> </thead> <tbody> <tr> <td>314303</td> <td>1 873 680 р.</td> </tr> </tbody> </table>	артикул	Цена за единицу	314303	1 873 680 р.	 <p>48,8x36x73,2h</p> <table border="1" data-bbox="1005 571 1492 660"> <thead> <tr> <th>№</th> <th>наименование</th> <th>артикул</th> <th>количество в изделии</th> <th>цена за единицу</th> </tr> </thead> <tbody> <tr> <td>1</td> <td>каркас шкафа</td> <td>316002</td> <td>1шт.</td> <td>1 227 840 р.</td> </tr> <tr> <td>2</td> <td>дверь</td> <td>315804</td> <td>1шт.</td> <td>424 440 р.</td> </tr> </tbody> </table>	№	наименование	артикул	количество в изделии	цена за единицу	1	каркас шкафа	316002	1шт.	1 227 840 р.	2	дверь	315804	1шт.	424 440 р.
артикул	Цена за единицу																			
314303	1 873 680 р.																			
№	наименование	артикул	количество в изделии	цена за единицу																
1	каркас шкафа	316002	1шт.	1 227 840 р.																
2	дверь	315804	1шт.	424 440 р.																
Полки навесные	Зеркало навесное																			
 <p>125x27x32h</p> <table border="1" data-bbox="550 828 782 896"> <thead> <tr> <th>артикул</th> <th>цена за единицу</th> </tr> </thead> <tbody> <tr> <td>316304</td> <td>733 080 р.</td> </tr> </tbody> </table>  <p>108x36x73,2h</p> <table border="1" data-bbox="550 1041 782 1108"> <thead> <tr> <th>артикул</th> <th>цена за единицу</th> </tr> </thead> <tbody> <tr> <td>316301</td> <td>1 617 720 р.</td> </tr> </tbody> </table>	артикул	цена за единицу	316304	733 080 р.	артикул	цена за единицу	316301	1 617 720 р.	 <p>90x1,9x65h</p> <table border="1" data-bbox="1260 1041 1492 1108"> <thead> <tr> <th>артикул</th> <th>цена за единицу</th> </tr> </thead> <tbody> <tr> <td>317801</td> <td>330 600 р.</td> </tr> </tbody> </table>	артикул	цена за единицу	317801	330 600 р.							
артикул	цена за единицу																			
316304	733 080 р.																			
артикул	цена за единицу																			
316301	1 617 720 р.																			
артикул	цена за единицу																			
317801	330 600 р.																			

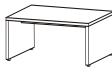
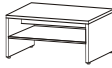
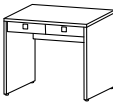
Все цены указаны с НДС.
 Основной цвет: гасиенда
 Дополнительные цвета: капучино, пастель

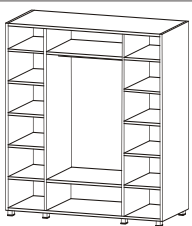
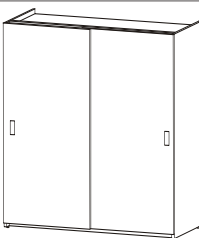

Прайс-лист цены на мебель для спальни ПАЛЕРМО (PALERMO), 11-02-2013 Софтформ

 <p>146 205,6 83,4h 166 205,6 83,4h 186 205,6 83,4h</p> <table border="1"> <tr><td>140 200</td><td>PLR-820140</td><td>3 730 080 p.</td></tr> <tr><td>160 200</td><td>PLR-820160</td><td>3 872 280 p.</td></tr> <tr><td>180 200</td><td>PLR-820180</td><td>4 023 960 p.</td></tr> </table>	140 200	PLR-820140	3 730 080 p.	160 200	PLR-820160	3 872 280 p.	180 200	PLR-820180	4 023 960 p.	 <p>160,4 205,6 83,4h 180,4 205,6 83,4h 200,4 205,6 83,4h</p> <table border="1"> <tr><td>140 200</td><td>PLR-820141</td><td>4 204 440 p.</td></tr> <tr><td>160 200</td><td>PLR-820161</td><td>4 346 280 p.</td></tr> <tr><td>180 200</td><td>PLR-820181</td><td>4 497 600 p.</td></tr> </table>	140 200	PLR-820141	4 204 440 p.	160 200	PLR-820161	4 346 280 p.	180 200	PLR-820181	4 497 600 p.	 <p>146 205,6 83,4h 166 205,6 83,4h 186 205,6 83,4h</p> <table border="1"> <tr><td>140 200</td><td>PLR-820142</td><td>6 178 320 p.</td></tr> <tr><td>160 200</td><td>PLR-820162</td><td>6 365 040 p.</td></tr> <tr><td>180 200</td><td>PLR-820182</td><td>6 560 160 p.</td></tr> </table>	140 200	PLR-820142	6 178 320 p.	160 200	PLR-820162	6 365 040 p.	180 200	PLR-820182	6 560 160 p.
140 200	PLR-820140	3 730 080 p.																											
160 200	PLR-820160	3 872 280 p.																											
180 200	PLR-820180	4 023 960 p.																											
140 200	PLR-820141	4 204 440 p.																											
160 200	PLR-820161	4 346 280 p.																											
180 200	PLR-820181	4 497 600 p.																											
140 200	PLR-820142	6 178 320 p.																											
160 200	PLR-820162	6 365 040 p.																											
180 200	PLR-820182	6 560 160 p.																											
 <p>146 205,6 83,4h 166 205,6 83,4h 186 205,6 83,4h</p> <table border="1"> <tr><td>140 200</td><td>PLR-820240</td><td>4 944 000 p.</td></tr> <tr><td>160 200</td><td>PLR-820260</td><td>5 086 200 p.</td></tr> <tr><td>180 200</td><td>PLR-820280</td><td>5 237 880 p.</td></tr> </table>	140 200	PLR-820240	4 944 000 p.	160 200	PLR-820260	5 086 200 p.	180 200	PLR-820280	5 237 880 p.	 <p>160,4 205,6 83,4h 180,4 205,6 83,4h 200,4 205,6 83,4h</p> <table border="1"> <tr><td>140 200</td><td>PLR-820241</td><td>5 418 360 p.</td></tr> <tr><td>160 200</td><td>PLR-820261</td><td>5 560 200 p.</td></tr> <tr><td>180 200</td><td>PLR-820210</td><td>5 711 520 p.</td></tr> </table>	140 200	PLR-820241	5 418 360 p.	160 200	PLR-820261	5 560 200 p.	180 200	PLR-820210	5 711 520 p.	 <p>146 205,6 83,4h 166 205,6 83,4h 186 205,6 83,4h</p> <table border="1"> <tr><td>140 200</td><td>PLR-820242</td><td>7 392 240 p.</td></tr> <tr><td>160 200</td><td>PLR-820262</td><td>7 578 960 p.</td></tr> <tr><td>180 200</td><td>PLR-820282</td><td>7 774 080 p.</td></tr> </table>	140 200	PLR-820242	7 392 240 p.	160 200	PLR-820262	7 578 960 p.	180 200	PLR-820282	7 774 080 p.
140 200	PLR-820240	4 944 000 p.																											
160 200	PLR-820260	5 086 200 p.																											
180 200	PLR-820280	5 237 880 p.																											
140 200	PLR-820241	5 418 360 p.																											
160 200	PLR-820261	5 560 200 p.																											
180 200	PLR-820210	5 711 520 p.																											
140 200	PLR-820242	7 392 240 p.																											
160 200	PLR-820262	7 578 960 p.																											
180 200	PLR-820282	7 774 080 p.																											
 <p>50 40,5 37,4h</p> <table border="1"> <tr><td>PLR-251001</td><td>728 640 p.</td></tr> </table>	PLR-251001	728 640 p.	 <p>70 40,5 37,4h</p> <table border="1"> <tr><td>PLR-271001</td><td>813 240 p.</td></tr> </table>	PLR-271001	813 240 p.	 <p>50 40,5 43h</p> <table border="1"> <tr><td>PLR-252000</td><td>1 208 400 p.</td></tr> </table>	PLR-252000	1 208 400 p.																					
PLR-251001	728 640 p.																												
PLR-271001	813 240 p.																												
PLR-252000	1 208 400 p.																												
 <p>70 40,5 43h</p> <table border="1"> <tr><td>PLR-272000</td><td>1 429 200 p.</td></tr> </table>	PLR-272000	1 429 200 p.	 <p>70 40,5 89,5h</p> <table border="1"> <tr><td>PLR-273001</td><td>1 979 760 p.</td></tr> </table>	PLR-273001	1 979 760 p.	 <p>90 40,5 89,5h</p> <table border="1"> <tr><td>PLR-293001</td><td>2 431 680 p.</td></tr> </table>	PLR-293001	2 431 680 p.																					
PLR-272000	1 429 200 p.																												
PLR-273001	1 979 760 p.																												
PLR-293001	2 431 680 p.																												
 <p>70 40,5 105h</p> <table border="1"> <tr><td>PLR-273000</td><td>2 032 800 p.</td></tr> </table>	PLR-273000	2 032 800 p.	 <p>90 40,5 105h</p> <table border="1"> <tr><td>PLR-293000</td><td>2 576 160 p.</td></tr> </table>	PLR-293000	2 576 160 p.	 <p>70 40,5 105h</p> <table border="1"> <tr><td>PLR-274001</td><td>2 421 240 p.</td></tr> </table>	PLR-274001	2 421 240 p.																					
PLR-273000	2 032 800 p.																												
PLR-293000	2 576 160 p.																												
PLR-274001	2 421 240 p.																												

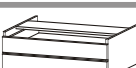
Прайс-лист цены на мебель для спальни ПАЛЕРМО (PALERMO), 11-02-2013 Софтформ

 <p>55 55 2,2h</p> <table border="1"> <tr> <td>PLR-055130</td> <td>371 880 p.</td> </tr> </table>	PLR-055130	371 880 p.	 <p>70 50 2h</p> <table border="1"> <tr> <td>PLR-075330</td> <td>1 144 800 p.</td> </tr> </table>	PLR-075330	1 144 800 p.	 <p>70 70 38h</p> <table border="1"> <tr> <td>PLR-177103</td> <td>774 840 p.</td> </tr> </table>	PLR-177103	774 840 p.		
PLR-055130	371 880 p.									
PLR-075330	1 144 800 p.									
PLR-177103	774 840 p.									
 <p>80 80 12,8h</p> <table border="1"> <tr> <td>PLR-188103</td> <td>508 080 p.</td> </tr> </table>	PLR-188103	508 080 p.	 <p>90 50 42h</p> <table border="1"> <tr> <td>PLR-194103</td> <td>571 440 p.</td> </tr> </table>  <p>90 50 42h</p> <table border="1"> <tr> <td>PLR-171601</td> <td>743 760 p.</td> </tr> </table>	PLR-194103	571 440 p.	PLR-171601	743 760 p.	 <p>90 55,5 76h</p> <table border="1"> <tr> <td>PLR-195100</td> <td>1 694 160 p.</td> </tr> </table>	PLR-195100	1 694 160 p.
PLR-188103	508 080 p.									
PLR-194103	571 440 p.									
PLR-171601	743 760 p.									
PLR-195100	1 694 160 p.									
 <p>150,4 60 220,2h</p> <table border="1"> <tr> <td>PLR-416611</td> <td>4 076 880 p.</td> </tr> </table>	PLR-416611	4 076 880 p.	 <p>198,6 60 220,2h</p> <table border="1"> <tr> <td>PLR-426611</td> <td>5 625 960 p.</td> </tr> </table>	PLR-426611	5 625 960 p.	 <p>203,6 62,9 223,2h</p> <table border="1"> <tr> <td>PLR-426612</td> <td>9 135 360 p.</td> </tr> </table>	PLR-426612	9 135 360 p.		
PLR-416611	4 076 880 p.									
PLR-426611	5 625 960 p.									
PLR-426612	9 135 360 p.									
 <p>207,8 48 1,8h</p> <p>PLR-416611, PLR-626611</p> <table border="1"> <tr> <td>PLR-556101</td> <td>490 920 p.</td> </tr> </table>	PLR-556101	490 920 p.	<p>(1)</p>  <p>37,9 55,8 32,2h</p> <p>PLR-416611, PLR-626611</p> <table border="1"> <tr> <td>PLR-251200</td> <td>706 200 p.</td> </tr> </table>	PLR-251200	706 200 p.	<p>(1)</p>  <p>97,5 57,8 32,2h</p> <p>- PLR-426612</p> <table border="1"> <tr> <td>PLR-291201</td> <td>915 000 p.</td> </tr> </table>	PLR-291201	915 000 p.		
PLR-556101	490 920 p.									
PLR-251200	706 200 p.									
PLR-291201	915 000 p.									
 <p>207,8 48 2h</p> <p>PLR-416611, PLR-626611</p> <table border="1"> <tr> <td>PLR-556331</td> <td>2 320 320 p.</td> </tr> </table>	PLR-556331	2 320 320 p.	<p>(2)</p>  <p>37,9 55,8 32,2h</p> <p>PLR-416611, PLR-626611</p> <table border="1"> <tr> <td>PLR-252200</td> <td>978 000 p.</td> </tr> </table>	PLR-252200	978 000 p.	<p>(2)</p>  <p>97,5 57,8 32,2h</p> <p>- PLR-426612</p> <table border="1"> <tr> <td>PLR-292201</td> <td>1 274 280 p.</td> </tr> </table>	PLR-292201	1 274 280 p.		
PLR-556331	2 320 320 p.									
PLR-252200	978 000 p.									
PLR-292201	1 274 280 p.									

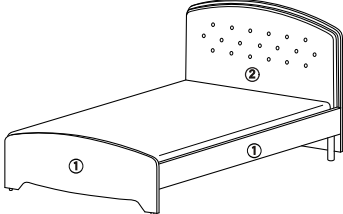
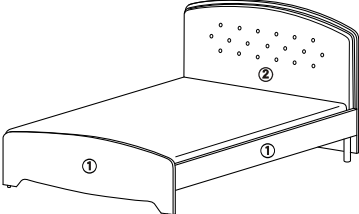
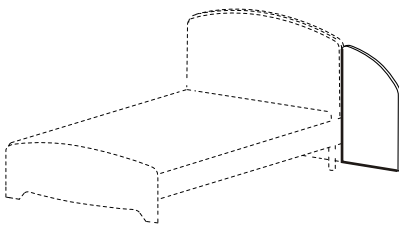
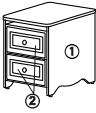
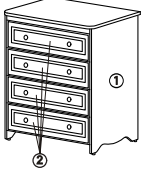
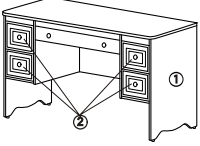
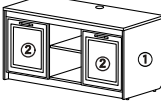
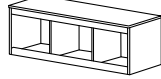
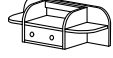
Прайс-лист цены на мебель для спальни **СТРЕКОЗА**, 11-02-2013 Софтформ

Кровать без матраса		Кровать без матраса																															
 <p>165,4x211,3x109h</p> <p>ортопедическое основание, место под матрас размером 160x200</p> <table border="1"> <thead> <tr> <th>№</th> <th>наименование</th> <th>артикул</th> <th>количество в изделии</th> <th>цена за единицу</th> </tr> </thead> <tbody> <tr> <td>1</td> <td>каркас кровати</td> <td>318616</td> <td>1 комплект</td> <td>3 694 200 р.</td> </tr> <tr> <td>2</td> <td>спинка кровати</td> <td>318160</td> <td>1шт.</td> <td>3 194 760 р.</td> </tr> </tbody> </table>		№	наименование	артикул	количество в изделии	цена за единицу	1	каркас кровати	318616	1 комплект	3 694 200 р.	2	спинка кровати	318160	1шт.	3 194 760 р.	 <p>185,4x211,3x109h</p> <p>ортопедическое основание, место под матрас размером 180x200</p> <table border="1"> <thead> <tr> <th>№</th> <th>наименование</th> <th>артикул</th> <th>количество в изделии</th> <th>цена за единицу</th> </tr> </thead> <tbody> <tr> <td>1</td> <td>каркас кровати</td> <td>318618</td> <td>1 комплект</td> <td>3 904 080 р.</td> </tr> <tr> <td>2</td> <td>спинка кровати</td> <td>318180</td> <td>1шт.</td> <td>3 452 400 р.</td> </tr> </tbody> </table>		№	наименование	артикул	количество в изделии	цена за единицу	1	каркас кровати	318618	1 комплект	3 904 080 р.	2	спинка кровати	318180	1шт.	3 452 400 р.
№	наименование	артикул	количество в изделии	цена за единицу																													
1	каркас кровати	318616	1 комплект	3 694 200 р.																													
2	спинка кровати	318160	1шт.	3 194 760 р.																													
№	наименование	артикул	количество в изделии	цена за единицу																													
1	каркас кровати	318618	1 комплект	3 904 080 р.																													
2	спинка кровати	318180	1шт.	3 452 400 р.																													
Спинка кровати боковая		Тумба прикроватная																															
 <p>61,6x1,8x93h</p> <table border="1"> <thead> <tr> <th>артикул (изображено)</th> <th>артикул (зеркально)</th> <th>цена за единицу</th> </tr> </thead> <tbody> <tr> <td>318062</td> <td>318061</td> <td>373 920 р.</td> </tr> </tbody> </table>		артикул (изображено)	артикул (зеркально)	цена за единицу	318062	318061	373 920 р.	 <p>51,6x55x58,8h</p> <table border="1"> <thead> <tr> <th>№</th> <th>наименование</th> <th>артикул</th> <th>количество в изделии</th> <th>цена за единицу</th> </tr> </thead> <tbody> <tr> <td>1</td> <td>каркас тумбы</td> <td>312902</td> <td>1шт.</td> <td>1 410 600 р.</td> </tr> <tr> <td>2</td> <td>фасад</td> <td>315852</td> <td>1 комплект</td> <td>767 160 р.</td> </tr> </tbody> </table>		№	наименование	артикул	количество в изделии	цена за единицу	1	каркас тумбы	312902	1шт.	1 410 600 р.	2	фасад	315852	1 комплект	767 160 р.									
артикул (изображено)	артикул (зеркально)	цена за единицу																															
318062	318061	373 920 р.																															
№	наименование	артикул	количество в изделии	цена за единицу																													
1	каркас тумбы	312902	1шт.	1 410 600 р.																													
2	фасад	315852	1 комплект	767 160 р.																													
Комод		Стол туалетный																															
 <p>96,6x55x103,2h</p> <table border="1"> <thead> <tr> <th>№</th> <th>наименование</th> <th>артикул</th> <th>количество в изделии</th> <th>цена за единицу</th> </tr> </thead> <tbody> <tr> <td>1</td> <td>каркас комода</td> <td>312901</td> <td>1шт.</td> <td>3 073 440 р.</td> </tr> <tr> <td>2</td> <td>фасад</td> <td>315894</td> <td>1 комплект</td> <td>1 808 040 р.</td> </tr> </tbody> </table>		№	наименование	артикул	количество в изделии	цена за единицу	1	каркас комода	312901	1шт.	3 073 440 р.	2	фасад	315894	1 комплект	1 808 040 р.	 <p>106,2x55x84h</p> <table border="1"> <thead> <tr> <th>№</th> <th>наименование</th> <th>артикул</th> <th>количество в изделии</th> <th>цена за единицу</th> </tr> </thead> <tbody> <tr> <td>1</td> <td>каркас стола</td> <td>311922</td> <td>1шт.</td> <td>3 725 640 р.</td> </tr> <tr> <td>2</td> <td>фасад</td> <td>315834</td> <td>1 комплект</td> <td>1 419 840 р.</td> </tr> </tbody> </table>		№	наименование	артикул	количество в изделии	цена за единицу	1	каркас стола	311922	1шт.	3 725 640 р.	2	фасад	315834	1 комплект	1 419 840 р.
№	наименование	артикул	количество в изделии	цена за единицу																													
1	каркас комода	312901	1шт.	3 073 440 р.																													
2	фасад	315894	1 комплект	1 808 040 р.																													
№	наименование	артикул	количество в изделии	цена за единицу																													
1	каркас стола	311922	1шт.	3 725 640 р.																													
2	фасад	315834	1 комплект	1 419 840 р.																													
Тумба под телевизор		Дополнительные элементы																															
 <p>130x46x58,8h</p> <table border="1"> <thead> <tr> <th>№</th> <th>наименование</th> <th>артикул</th> <th>количество в изделии</th> <th>цена за единицу</th> </tr> </thead> <tbody> <tr> <td>1</td> <td>каркас тумбы</td> <td>312904</td> <td>1шт.</td> <td>1 642 560 р.</td> </tr> <tr> <td>2</td> <td>дверь</td> <td>315820</td> <td>1 комплект</td> <td>641 160 р.</td> </tr> </tbody> </table>		№	наименование	артикул	количество в изделии	цена за единицу	1	каркас тумбы	312904	1шт.	1 642 560 р.	2	дверь	315820	1 комплект	641 160 р.	 <p>130x36x39,2h</p> <p>полка настенная</p> <table border="1"> <thead> <tr> <th>артикул</th> <th>цена за единицу</th> </tr> </thead> <tbody> <tr> <td>316305</td> <td>984 480 р.</td> </tr> </tbody> </table>  <p>92x26,8x29,2h</p> <p>полка настольная</p> <table border="1"> <thead> <tr> <th>артикул</th> <th>цена за единицу</th> </tr> </thead> <tbody> <tr> <td>316402</td> <td>1 078 440 р.</td> </tr> </tbody> </table>  <p>90x1,9x65h</p> <p>зеркало навесное</p> <table border="1"> <thead> <tr> <th>артикул</th> <th>цена за единицу</th> </tr> </thead> <tbody> <tr> <td>317801</td> <td>330 600 р.</td> </tr> </tbody> </table>		артикул	цена за единицу	316305	984 480 р.	артикул	цена за единицу	316402	1 078 440 р.	артикул	цена за единицу	317801	330 600 р.			
№	наименование	артикул	количество в изделии	цена за единицу																													
1	каркас тумбы	312904	1шт.	1 642 560 р.																													
2	дверь	315820	1 комплект	641 160 р.																													
артикул	цена за единицу																																
316305	984 480 р.																																
артикул	цена за единицу																																
316402	1 078 440 р.																																
артикул	цена за единицу																																
317801	330 600 р.																																

Все цены указаны с НДС.

Основной цвет: гасиенда

Дополнительные цвета: капучино, пастель

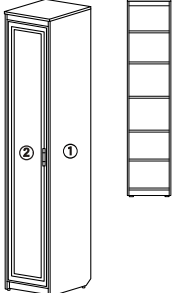
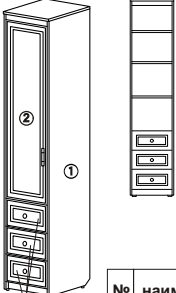
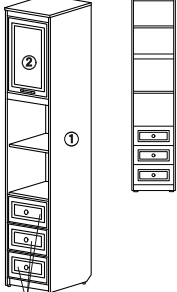
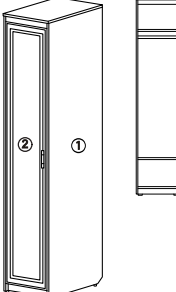
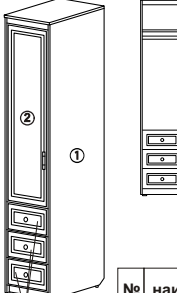
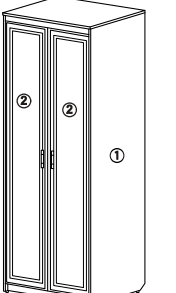
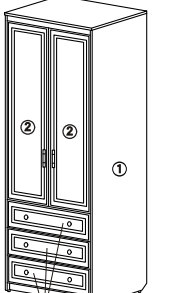
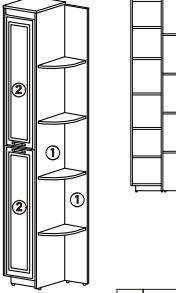
Шкаф					Шкаф					
 <p>48,8x46x224h</p>					 <p>48,8x46x224h</p>					
№	наименование	артикул	количество в изделии	цена за единицу	№	наименование	артикул (изображено)	артикул (зеркально)	количество в изделии	цена за единицу
1	каркас шкафа	314101	1шт.	2 380 560 р.	1	каркас шкафа	314102		1шт.	3 218 160 р.
2	дверь	315801	1шт.	746 520 р.	2	дверь	315802	315803	1шт.	594 240 р.
					3	фасад	315853		1 комплект	1 141 920 р.
Шкаф					Шкаф-гардероб					
 <p>48,8x46x224h</p>					 <p>48,8x61x224h</p>					
№	наименование	артикул	количество в изделии	цена за единицу	№	наименование	артикул	количество в изделии	цена за единицу	
1	каркас шкафа	314103	1шт.	3 315 120 р.	1	каркас шкафа	314104	1шт.	2 346 240 р.	
2	дверь	315804	1шт.	424 440 р.	2	дверь	315801	1шт.	746 520 р.	
3	фасад	315853	1 комплект	1 141 920 р.						
Шкаф-гардероб					Шкаф-гардероб					
 <p>48,8x61x224h</p>					 <p>93,8x61x224h</p>					
№	наименование	артикул (изображено)	артикул (зеркально)	количество в изделии	цена за единицу	№	наименование	артикул	количество в изделии	цена за единицу
1	каркас шкафа	314105		1шт.	3 309 360 р.	1	каркас шкафа	314118	1шт.	3 149 400 р.
2	дверь	315802	315803	1шт.	594 240 р.	2	дверь	315811	1 комплект	1 470 600 р.
3	фасад	315853		1 комплект	1 141 920 р.					
Шкаф-гардероб					Шкаф-окончание					
 <p>93,8x61x224h</p>					 <p>33,4x60,4x224h</p>					
№	наименование	артикул	количество в изделии	цена за единицу	применяется со шкафами глубиной 61см.					
1	каркас шкафа	314106	1шт.	4 280 160 р.	№	наименование	артикул (изображено)	артикул (зеркально)	количество в изделии	цена за единицу
2	дверь	315822	1 комплект	1 165 200 р.	1	каркас шкафа	314113	314112	1шт.	2 922 720 р.
3	фасад	315893	1 комплект	1 407 120 р.	2	дверь	315833		1 комплект	864 000 р.

Все цены указаны с НДС.

Основной цвет: гасиенда

Дополнительные цвета: капучино, пастель

Прайс-лист цены на мебель для спальни **СТРЕКОЗА**, 11-02-2013 Софтформ

Шкаф-гардероб

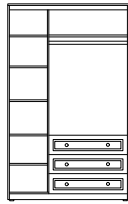
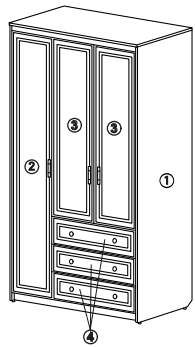

138,8x61x224h

№	наименование	артикул (изображено)	артикул (зеркально)	количество в изделии	цена за единицу
1	каркас шкафа	314107	314117	1шт.	5 656 920 р.
2	дверь	315801		1шт.	746 520 р.
3	дверь	315822		1 комплект	1 165 200 р.
4	фасад	315893		1 комплект	1 407 120 р.

Шкаф-гардероб

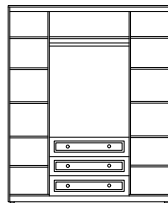
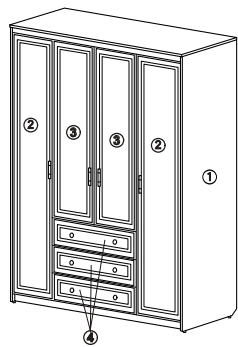

183,8x61x224h

№	наименование	артикул (изображено)	количество в изделии	цена за единицу
1	каркас шкафа	314124	1шт.	7 035 000 р.
2	дверь	315811	1 комплект	1 470 600 р.
3	дверь	315822	1 комплект	1 165 200 р.
4	фасад	315893	1 комплект	1 407 120 р.

Шкаф-гардероб угловой

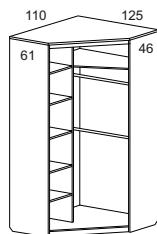
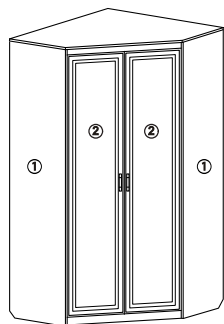

110x125x224h

№	наименование	артикул (изображено)	артикул (зеркально)	количество в изделии	цена за единицу
1	каркас шкафа	314125	314126	1шт.	5 459 040 р.
2	дверь	315811		1 комплект	1 470 600 р.

Шкаф-гардероб угловой

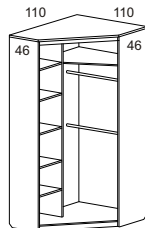
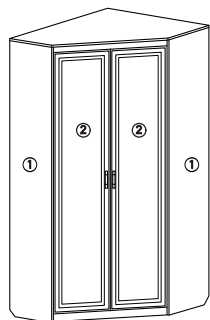

110x110x224h

№	наименование	артикул	количество в изделии	цена за единицу
1	каркас шкафа	314108	1шт.	4 794 840 р.
2	дверь	315811	1 комплект	1 470 600 р.

Стеллаж-окончание

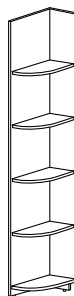

30x45,4x222,2h

применяется со шкафами глубиной 46см.

артикул (изображено)	артикул (зеркально)	цена за единицу
314301	314302	1 474 080 р.

Все цены указаны с НДС.

Основной цвет: гасиенда

Дополнительные цвета: капучино, пастель